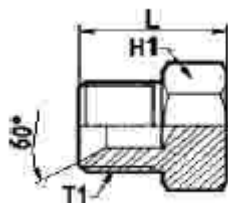
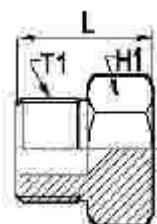
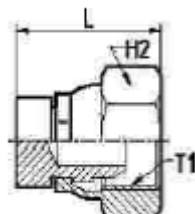

**714
BSP 60° (ISO 228-PF)**

Артикул Сталь	Артикул Нерж. Сталь AISI	Резьба T1 (BSPP)	Размеры, мм	
			L	H
714-02	714i-02	1/8	18	12
714-04	714i-04	1/4	19	14
714-06	714i-06	3/8	22	19
714-08	714i-08	1/2	28	22
714-12	714i-12	3/4	30	27
714-16	714i-16	1	34	35
714-20	714i-20	1 1/4	38	43
714-24	714i-24	1 1/2	41	50

**2082
NPTF**

Артикул Сталь	Резьба T1 (BSPP)	Размеры, мм	
		L	H1
2082-02	1/8	15	14
2082-04	1/4	21,5	14
2082-06	3/8	21,5	19
2082-08	1/2	28	22
2082-12	3/4	30	27
2082-16	1	34,5	38
2082-20	1 1/4	37	50
2082-24	1 1/2	39	50

**713
BSP 60° (ISO 228-PF)**

Артикул Сталь	Артикул Нерж. Сталь AISI	Резьба T1 (BSPP)	Размеры, мм	
			L	H2
713-02	713i-02	1/8	21	14
713-04	713i-04	1/4	24	19
713-06	713i-06	3/8	29	22
713-08	713i-08	1/2	33	27
713-12	713i-12	3/4	38	32
713-16	713i-16	1	44	41
713-20	713i-20	1 1/4	45	50
713-24	713i-24	1 1/2	49	55

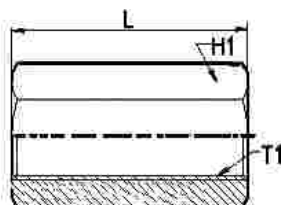
709
BSP (ISO 1179-3)
СТАЛЬ

Артикул Сталь	Резьба	Размеры, мм	
	T1 (BSPP)	L	H1
709-02	1/8	23	14
709-04	1/4	23	19
709-06	3/8	29	22
709-08	1/2	33	27
709-10	5/8	41	30
709-12	3/4	41	32
709-16	1	42	41
709-20	1 1/4	48	50
709-24	1 1/2	51	55

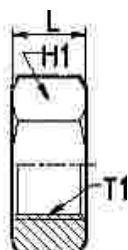
2012
BSP (ISO 1179-3)
СТАЛЬ

Артикул Сталь	Резьба	Размеры, мм	
	T1 (BSPP)	L	H1
2012-04	1/4	6,5	19
2012-06	3/8	7,5	22
2012-08	1/2	9	27
2012-12	3/4	10	32
2012-16	1	10	41
2012-20	1 1/4	10	50
2012-24	1 1/2	10	55
2012-32	2	13	70

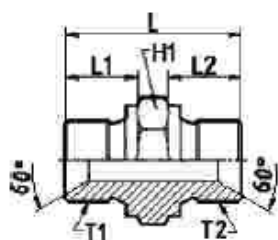
201
202
BSP 60° (ISO 228-PF)
СТАЛЬ

Артикул Сталь	Нерж. сталь AISI	Резьба		Размеры, мм			
		T1 (BSPP)	T2 (BSPP)	L	L1	L2	H1
201-02-02	201i-02-02	1/8	1/8	24	8	8	14
202-02-04	202i-02-04	1/8	1/4	29	8	11	19
201-04-04	201i-04-04	1/4	1/4	32	11	11	19
202-04-06	202i-04-06	1/4	3/8	33	11	12	22
202-04-08	202i-04-08	1/4	1/2	37,5	11	14	27
201-06-06	201i-06-06	3/8	3/8	35	12	12	22
202-06-08	202i-06-08	3/8	1/2	38	12	14	27
202-06-12	202i-06-12	3/8	3/4	42	12	16	32
201-08-08	201i-08-08	1/2	1/2	41	14	14	27
202-08-10	202i-08-10	1/2	5/8	43	14	16	30
202-08-12	202i-08-12	1/2	3/4	45	14	16	32
202-08-16	202i-08-16	1/2	1	48,5	14	19	41
201-10-10	201i-10-10	5/8	5/8	44,5	16	16	30
202-10-12	202i-10-12	5/8	3/4	47	16	16	32
201-12-12	201i-12-12	3/4	3/4	47,5	16	16	32
202-12-16	202i-12-16	3/4	1	51,5	16	19	41
202-12-20	202i-12-20	3/4	1 1/4	56,5	19	26	44
201-16-16	201i-16-16	1	1	54	19	19	41
202-16-20	202i-16-20	1	1 1/4	60	22	26	44
201-20-20	201i-20-20	1 1/4	1 1/4	65	26	26	44
202-20-24	202i-20-24	1 1/4	1 1/2	66,5	26	27,5	50
201-24-24	201i-24-24	1 1/2	1 1/2	71	27,5	27,5	50
201-32-32	201i-32-32	2	2	80	31	31	65

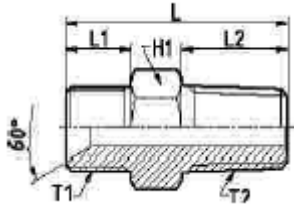
**203
BSP 60°-BSPT (ISO
7-PT)**

Артикул Сталь	Нерж. Сталь AISI	Резьба		Размеры, мм			
		T1 (BSPP)	T2 (BSPT)	L	L1	L2	H1
203-04	203i-04	1/4	1/4	33	13	14	14
203-04-06	203i-04-06	1/4	3/8	37	13	16	19
203-06-04	203i-06-04	3/8	1/4	37	15	14	19
203-06	203i-06	3/8	3/8	39	15	16	19
203-06-08	203i-06-08	3/8	1/2	43	15	18	22
203-08-06	203i-08-06	1/2	3/8	44	18	16	22
203-08	203i-08	1/2	1/2	46	18	18	22
203-08-12	203i-08-12	1/2	3/4	49	18	20	27
203-12-08	203i-12-08	3/4	1/2	49	20	18	27
203-12	203i-12	3/4	3/4	51	20	20	27
203-12-16	203i-12-16	3/4	1	55	20	23	35
203-16-12	203i-16-12	1	3/4	54	22	20	35
203-16	203i-16	1	1	57	22	23	35
203-20-20	203i-20-20	1 1/4	1 1/4	65	26	26	44
203-24	203i-24	1 1/2	1 1/2	71	27,5	29	50
203-32	203i-32	2	2	85	31	34	65

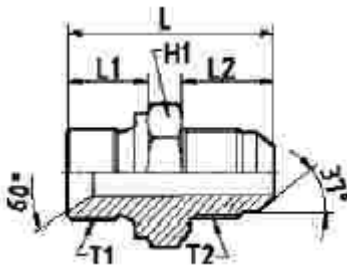
**206
BSP 60°/JIC 74°
(ISO 228-PF)(SAE
J514)**

Артикул Сталь	Резьба		Размеры, мм			
	T1 (BSPP)	T2 (UNF)	L	L1	L2	H1
206-02-04	1/8	7/16	30,5	10	14	14
206-04-04	1/4	7/16	31	11	14	19
206-04-05	1/4	1/2	31	11	14	19
206-04-06	1/4	9/16	32	11	14	19
206-04-08	1/4	3/4	37	11	17	19
206-06-06	3/8	9/16	34,5	13	11	22
206-06-08	3/8	3/4	37	13	17	22
206-08-08	1/2	3/4	42	15	17	27
206-08-06	1/2	9/16	40	15	14	22
206-08-10	1/2	7/8	45	15	19	27
206-08-12	1/2	11/16	47	15	22	27
206-10-10	5/8	7/8	41	16	19	30
206-12-12	3/4	11/16	48	16	22	32
206-12-08	3/4	3/4	44	16	17	32
206-12-10	3/4	7/8	47	16	19	32
206-12-14	3/4	13/16	52	16	23	32
206-12-16	3/4	1 5/16	52	16	23	38
206-12-20	3/4	1 5/8	53	16	24,5	44,5
206-16-12	1	1 1/16	57,5	19	22	41
206-16-14	1	1 5/16	54	19	23	41
206-16-20	1	1 5/8	60	19	24,5	44,5

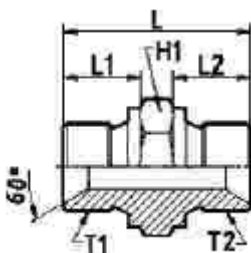
**208
BSP 60°/M (ISO
228-PF) (ISO 6149)**

Артикул Сталь	Резьба		Размеры, мм			
	T1 (BSPP)	T2 (METRIC)	L	L1	L2	H1
208-04-12	1/4	M 12X1,5	31	11	11	19
208-04-14	1/4	M 14X1,5	31	11	11	19
208-04-16	1/4	M 16X1,5	34	11	13	22
208-06-14	3/8	M 14X1,5	34	13	11	22
208-06-18	3/8	M 18X1,5	35,5	13	13	22
208-08-18	1/2	M 18X1,5	41	13	15	27
208-08-20	1/2	M 20X1,5	44	15	15	27
208-08-22	1/2	M 22X1,5	44	15	15	27
208-08-26	1/2	M 26X1,5	47	15	16	32
208-12-22	3/4	M 22X1,5	45	16	15	32
208-12-26	3/4	M 26X1,5	47	16	16	32

2011
BSP 60°
(ISO 228-PF)
СТАЛЬ

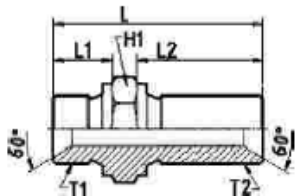

Артикул Сталь	Резьба		Размеры, мм			
	T1 (BSPP)	T2 (BSPP)	L	L1	L2	H1
2011-04	1/4	1/4	44	11	26	19
2011-06	3/8	3/8	48	13	28	22
2011-08	1/2	1/2	58	15	33	27
2011-12	3/4	3/4	59	16	34	32
2011-16	1	1	75	19	40	41
2011-20	1 1/4	1 1/4	77	20	40	50
2011-24	1 1/2	1 1/2	79	23	40	55
2011-32	2	2	97	26	52	70

705
BSP 60°
(ISO 228-PF)
СТАЛЬ

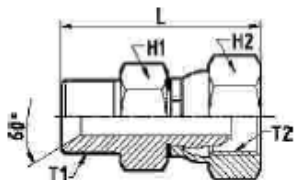

Артикул Сталь	Артикул Нерж. сталь AISI	Резьба		Размеры, мм		
		T1 (BSPP)	T1 (BSPP)	L	H1	H2
705-02-02	705i-02-02	1/8	1/8	30	14	14
705-02-04	705i-02-04	1/8	1/4	33	14	19
705-04-02	705i-04-02	1/4	1/8	33	19	14
705-04-04	705i-04-04	1/4	1/4	36	14	19
705-04-06	705i-04-06	1/4	3/8	36	19	22
705-04-08	705i-04-08	1/4	1/2	40	19	27
705-06-04	705i-06-04	3/8	1/4	37	22	19
705-06-06	705i-06-06	3/8	3/8	41	19	22
705-06-08	705i-06-08	3/8	1/2	42	22	26
705-08-04	705i-08-04	1/2	1/4	42	27	19
705-08-06	705i-08-06	1/2	3/8	43	27	22
705-08-08	705i-08-08	1/2	1/2	50	22	27
705-08-10	705i-08-10	1/2	5/8	49	22	30
705-08-12	705i-08-12	1/2	3/4	50	32	32
705-10-08	705i-10-08	5/8	1/2	43	30	26
705-10-10	705i-10-10	5/8	5/8	50	30	30
705-10-12	705i-10-12	5/8	3/4	51	30	32
705-12-08	705i-12-08	3/4	1/2	48	32	27
705-12-10	705i-12-10	3/4	5/8	54	32	27
705-12-12	705i-12-12	3/4	3/4	56	27	32
705-12-16	705i-12-16	3/4	1	55	32	38
705-16-12	705i-16-12	1	3/4	54	41	32
705-16-16	705i-16-16	1	1	66	35	41
705-16-20	705i-16-20	1	1 1/4	60	41	50
705-20-16	705i-20-16	1 1/4	1	62	50	38
705-20-20	705i-20-20	1 1/4	1 1/4	70	44	50
705-24-20	705i-24-20	1 1/2	1 1/4	67	55	50
705-24-24	705i-24-24	1 1/2	1 1/2	80	50	55
705-32-24	705i-32-24	2	1 1/2	85	70	55
705-32-32	705i-32-32	2	2	85	70	70

707
BSP 60°
(ISO 228-
PF)
СТАЛЬ

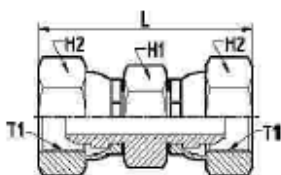

Артикул Сталь	Артикул Нерж. сталь AISI	Резьба	Размеры, мм		
		T1 (BSPP)	L	H1	H2
707-04	707i-04	1/4	42	14	19
707-06	707i-06	3/8	47	19	22
707-08	707i-08	1/2	54	22	27
707-12	707i-12	3/4	65	27	32
707-16	707i-16	1	74	35	41
707-20	707i-20	1 1/4	77	44	50
707-24	707i-24	1 1/2	85	50	55

700S

45°, резьба
BSP 60°/BSP
(ISO 228-PF)
(ISO 1179-3)

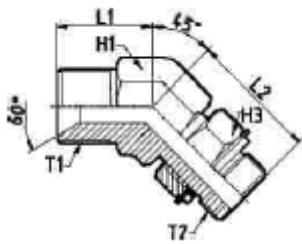

Артикул Сталь	Артикул Нерж. Сталь AISI	Резьба		Размеры, мм			
		T1 (BSPP)	T2 (BSPP)	L1	L2	H1	H3
700S-04-04	700Si-04-04	1/4	1/4	21	28	14	19
700S-04-06	700Si-04-06	1/4	3/8	23	33	19	22
700S-06-04	700Si-06-04	3/8	1/4	25	33	19	19
700S-06-06	700Si-06-06	3/8	3/8	25	33	19	22
700S-06-08	700Si-06-08	3/8	1/2	26	38,5	22	27
700S-08-06	700Si-08-06	1/2	3/8	28	38,5	22	22
700S-08-08	700Si-08-08	1/2	1/2	28	38,5	22	27
700S-08-12	700Si-08-12	1/2	3/4	30	43	27	32
700S-12-08	700Si-12-08	3/4	1/2	33	43	27	27
700S-12-12	700Si-12-12	3/4	3/4	33	43	27	32
700S-12-16	700Si-12-16	3/4	1	35	46	35	41
700S-16-12	700Si-16-12	1	3/4	38	46	35	32
700S-16-16	700Si-16-16	1	1	38	46	35	41
700S-16-20	700Si-16-20	1	1 1/4	40	48,5	44	50
700S-20-16	700Si-20-16	1 1/4	1	45	48,5	44	41
700S-20-20	700Si-20-20	1 1/4	1 1/4	45	48,5	44	50

703

45°, резьба BSP
60° (ISO 228-PF)
СТАЛЬ

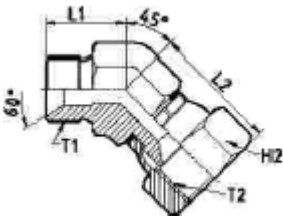

Артикул Сталь	Резьба		Размеры, мм		
	T1 (BSPP)	T2 (BSPP)	L1	L2	H2
703-02T	1/8	1/8	27	27	14
703-04T	1/4	1/4	30	30	19
703-06T	3/8	3/8	30	30	22
703-08T	1/2	1/2	34	34	27
703-10T	5/8	5/8	37,5	37,5	30
703-12T	3/4	3/4	37,5	37,5	32
703-16T	1	1	46	46	38

701

90° резьба,
BSP 60°/BSPT
(ISO 228-PF)
(ISO 7-PT)
СТАЛЬ

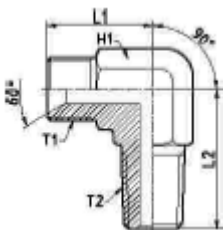

Артикул Сталь	Нерж. Сталь AISI	Резьба		Размеры, мм		
		T1 (BSPP)	T2 (BSPP)	L1	L2	H1
701-04-04	701i-04-04	1/4	1/4	25	27	14
701-06-06	701i-06-06	3/8	3/8	29	31	19
701-08-08	701i-08-08	1/2	1/2	33	37	22
701-12-12	701i-12-12	3/4	3/4	38	42	27
701-16-16	701i-16-16	1	1	45	48	35
701-20-20	701i-20-20	1 1/4	1 1/4	52	57	41
701-24-24	701i-24-24	1 1/2	1 1/2	59	65	50
701-32-32	701i-32-32	2	2	73	74	65

701S
90° BSP 60°/BSP
(ISO 228-PF)
(ISO 1179-3)
СТАЛЬ

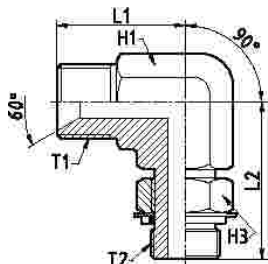

704T
90° /BSP 60°
(ISO 228-PF)
СТАЛЬ

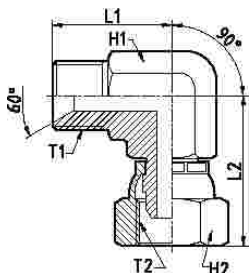

701P
90° /BSP 60°
(ISO 228-PF)
СТАЛЬ

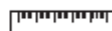
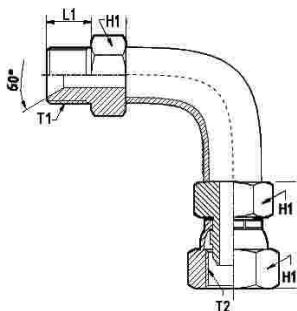

Артикул Сталь	Артикул Нерж. сталь AISI	Резьба		Размеры, мм			
		T1 (BSPP)	T1 (BSPP)	L1	L2	H1	H3
701S-04	701Si-04	¼	¼	25	31,5	14	19
701S-04-06	701Si-04-06	¼	3/8	26	36,5	19	22
701S-06-04	701Si-06-04	3/8	¼	29	33,5	19	19
701S-06	701Si-06	3/8	3/8	29	36,5	19	22
701S-06-08	701Si-06-08	3/8	½	30	43	22	27
701S-08-06	701Si-08-06	½	3/8	33	39,5	22	22
701S-08	701Si-08	½	½	33	43	22	27
701S-08-12	701Si-08-12	½	¾	36	49	27	32
701S-12-08	701Si-12-08	¾	½	38	45,5	27	27
701S-12	701Si-12	¾	¾	38	49	27	32
701S-12-16	701Si-12-16	¾	1	42	52	35	41
701S-16-12	701Si-16-12	1	¾	45	52	35	32
701S-16	701Si-16	1	1	45	52	35	41
701S-16-20	701Si-16-20	1	1 ¼	52	57	41	50
701S-20-16	701Si-20-16	1 ¼	1	52	57	41	41
701S-20	701Si-20	1 ¼	1 ¼	52	57	41	50



Артикул Сталь	Артикул Нерж. сталь AISI	Резьба		Размеры, мм			
		T1 (BSPP)	T1 (BSPP)	L1	L2	H1	H3
704T-04	704Ti-04	¼	¼	25	28	14	19
704T-06	704Ti-06	3/8	3/8	29	31	19	22
704T-08	704Ti-08	½	½	33	37	22	27
704T-12	704Ti-12	¾	¾	38	45	27	32
704T-16	704Ti-16	1	1	45	54	35	41
704T-20	704Ti-20	1 ¼	1 ¼	52	62	41	50
704T-24	704Ti-24	1 ½	1 ½	59	73	50	55

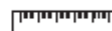

Артикул Сталь	Резьба		Размеры, мм	
	T1 (BSPP)	T2 (BSPP)	L	H1
701P-04	¼	¼	36	19
701P-06	3/8	3/8	43	22
701P-08	½	½	50	27
701P-12	¾	¾	66	32
701P-16	1	1	76	38
701P-20	1 ¼	1 ¼	83	50
701P-24	1 ½	1 ½	100	55

702
резьба BSP
60°(ISO 228-PF)
СТАЛЬ

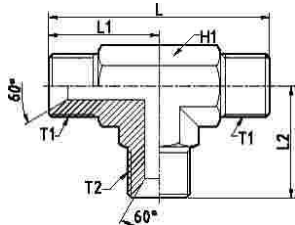

Артикул Сталь	Артикул Нерж. Сталь AISI	Резьба		Размеры, мм			
		T1 (BSPP)	T2 (BSPP)	L	L1	L2	H1
702-04-04	702i-04-04	1/4	1/4	50	25	25	14
702-06-06	702i-06-06	3/8	3/8	58	29	29	19
702-08-08	702i-08-08	1/2	1/2	66	33	33	22
702-12-12	702i-12-12	3/4	3/4	76	38	38	27
702-16-16	702i-16-16	1	1	90	45	45	35
702-20-20	702i-20-20	1 1/4	1 1/4	104	52	52	41
702-24-24	702i-24-24	1 1/2	1 1/2	118	59	59	50

702S
резьба BSP 60°
(ISO 228-PF)
СТАЛЬ

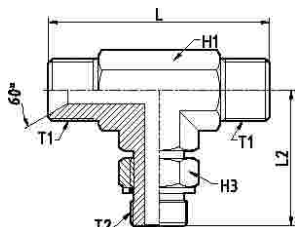

Артикул Сталь	Резьба		Размеры, мм			
	T1 (BSPP)	T2 (BSPP)	L1	L2	H1	H3
702S-04-04	1/4	1/4	50	31,5	14	19
702S-06-06	3/8	3/8	58	36,5	19	22
702S-08-08	1/2	1/2	66	43	22	27
702S-12-12	3/4	3/4	76	49	27	32
702S-16-16	1	1	90	52	35	41

712
резьба BSP 60°-
BSPT-BSP 60°
(ISO 228-PF) (ISO-
PT)
СТАЛЬ

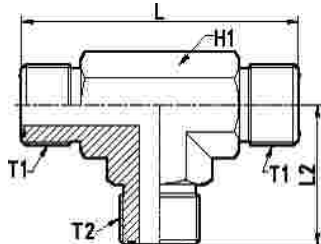

Артикул Сталь	Резьба		Размеры, мм	
	T1 (BSPP)	T2 (BSPP)	L1	L2
712-04	1/4	1/4	54	27
712-06	3/8	3/8	54	27
712-08	1/2	1/2	64	32
712-12	3/4	3/4	75	32
712-16	1	1	90	45

718
BSP 60°/BSP (ISO
228-PF) (ISO
1179-3)
СТАЛЬ

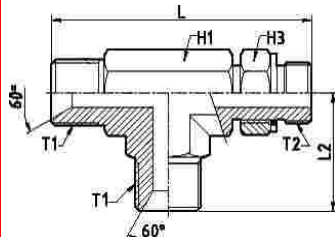

Артикул Сталь	Артикул Нерж. Сталь AISI	Резьба		Размеры, мм			
		T1 (BSPP)	T2 (BSPP)	L1	L2	H1	H3
718-04-04	718i-04-04	1/4	1/4	56,5	25	14	19
718-06-06	718i-06-06	3/8	3/8	65,5	29	19	22
718-08-08	718i-08-08	1/2	1/2	76	33	22	27
718-12-12	718i-12-12	3/4	3/4	89	38	27	32
718-16-16	718i-16-16	1	1	97	45	35	41
718-20-20	718i-20-20	1 1/4	1 1/4	109	52	41	50
718-24-24	718i-24-24	1 1/2	1 1/2	123	59	50	55

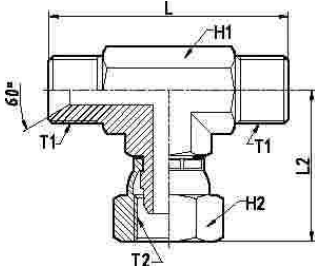
737
BSP 60° (ISO 228-
PF)

Артикул Сталь	Артикул Нерж. сталь AISI	Резьба		Размеры, мм			
		T1 (BSPP)	T1 (BSPP)	L	L2	H1	H2
737-04	737i-04	¼	¼	50	28	14	19
737-06	737i-06	3/8	3/8	58	31	19	22
737-08	737i-08	½	½	66	37	22	27
737-12	737i-12	¾	¾	76	45	27	32
737-16	737i-16	1	1	90	54	35	41
737-20	737i-20	1 ¼	1 ¼	104	62	41	50
737-24	737i-24	1 1/2	1 1/2	118	73	50	55

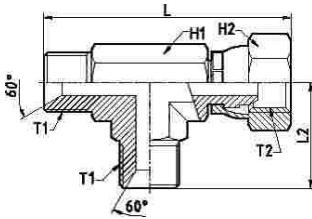
747
BSP 60° (ISO 228-
PF)

Артикул Сталь	Артикул Нерж. сталь AISI	Резьба		Размеры, мм			
		T1 (BSPP)	T1 (BSPP)	L	L2	H1	H2
747-04	747i-04	¼	¼	53	25	14	19
747-06	747i-06	3/8	3/8	60	29	19	22
747-08	747i-08	½	½	70	33	22	27
747-12	747i-12	¾	¾	83	38	27	32
747-16	747i-16	1	1	99	45	35	41
747-20	747i-20	1 ¼	1 ¼	113	51	41	50
747-24	747i-24	1 1/2	1 1/2	132	59	50	55

205027
45°

резьба BSP
60°/BSP (ISO
228-PF)
(ISO1179-3)
СТАЛЬ

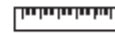
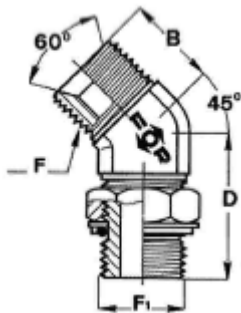

Артикул Сталь	Резьба		Размеры, мм	
	F(BSPP)	F1(BSPP)	B	D
A205027-1010	1/8	1/8	20	26
A205027-1013	1/8	1/4	21	28
A205027-1313	1/4	1/4	21	28
A205027-1317	1/4	3/8	22	33
A205027-1713	3/8	1/4	25	30
A205027-1717	3/8	3/8	25	33
A205027-1721	3/8	1/2	25,5	38
A205027-2117	1/2	3/8	28	35
A205027-2121	1/2	1/2	28	38
A205027-2126	1/2	3/4	30	44
A205027-2321	5/8	1/2	28	38
A205027-2621	3/4	1/2	32	40
A205027-2626	3/4	3/4	32	44
A205027-2633	3/4	1	35	47
A205027-3326	1	3/4	37	47
A205027-3333	1	1	37	47
A205027-3342	1	1 1/4	39	49
A205027-4242	1 1/4	1 1/4	40	49
A205027-4848	1 1/2	1 1/2	45	49

207030
90°

резьба BSP
60°/BSP (ISO
228-PF)
(ISO1179-3)
СТАЛЬ

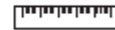
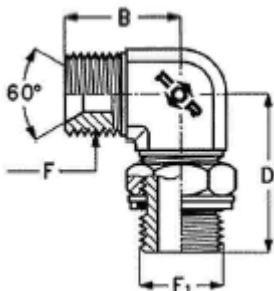

Артикул Сталь	Резьба		Размеры, мм	
	F(BSPP)	F1(BSPP)	B	D
A207030-1010	1/8	1/8	22	27
A207030-1013	1/8	1/4	24	31,5
A207030-1313	1/4	1/4	27	31,5
A207030-1317	1/4	3/8	28	37
A207030-1713	3/8	1/4	29	35
A207030-1717	3/8	3/8	29	37
A207030-1721	3/8	1/2	32	43
A207030-2117	1/2	3/8	34	40
A207030-2121	1/2	1/2	34	43
A207030-2126	1/2	3/4	39	50
A207030-2321	5/8	1/2	37	43
A207030-2621	3/4	1/2	41	46
A207030-2626	3/4	3/4	41	50
A207030-2633	3/4	1	43	53
A207030-3326	1	3/4	46	52
A207030-3333	1	1	46	53
A207030-3342	1	1 1/4	50	58
A207030-4242	1 1/4	1 1/4	51	58
A207030-4848	1 1/2	1 1/2	59	67

211021
BSP 60°(ISO
228-PF)
СТАЛЬ

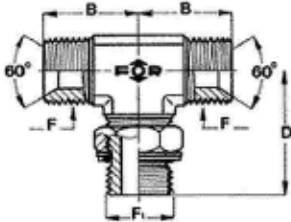

Артикул Сталь	Резьба		Размеры, мм	
	F(BSPP)	F1(BSPP)	B	D
A211021-1010	1/8	1/8	22	27
A211021-1013	1/8	¼	24	31,5
A211021-1313	¼	¼	27	31,5
A211021-1317	¼	3/8	28	37
A211021-1713	3/8	¼	29	35
A211021-1717	3/8	3/8	29	37
A211021-1721	3/8	½	32	43
A211021-2117	½	3/8	34	40
A211021-2121	½	½	34	43
A211021-2126	½	¾	39	50
A211021-2321	5/8	½	37	45
A211021-2621	¾	½	41	46
A211021-2626	¾	¾	41	50
A211021-2633	¾	1	43	53
A211021-3326	1	¾	46	52
A211021-3333	1	1	46	53
A211021-3342	1	1 ¼	50	58
A211021-4242	1 ¼	1 ¼	51	58
A211021-4848	1 ½	1 ½	59	67

213017
BSP 60°/ BSP
(ISO 228-PF)
(ISO 1179-3)
СТАЛЬ

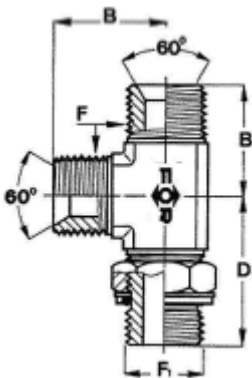

Артикул Сталь	Резьба		Размеры, мм	
	F(BSPP)	F1(BSPP)	B	D
A213017-1010	1/8	1/8	22	27
A213017-1013	1/8	¼	24	31,5
A213017-1313	¼	¼	27	31,5
A213017-1317	¼	3/8	28	37
A213017-1713	3/8	¼	29	35
A213017-1717	3/8	3/8	29	37
A213017-1721	3/8	½	32	43
A213017-2117	½	3/8	34	40
A213017-2121	½	½	34	43
A213017-2126	½	¾	39	50
A213017-2321	5/8	½	37	45
A213017-2621	¾	½	41	46
A213017-2626	¾	¾	41	50
A213017-2633	¾	1	43	53
A213017-3326	1	¾	46	52
A213017-3333	1	1	46	53
A213017-3342	1	1 ¼	50	58
A213017-4242	1 ¼	1 ¼	51	58
A213017-4848	1 ½	1 ½	59	67



ТАБЛИЦА РАЗМЕРОВ JIC



Размер трубы		JIC-SAE UNF/UN	PN бар	P макс. бар
мм	дюймов			
06	¼	7/16-20	350	500
08	5/16	½-20	350	500
10	3/8	9/16-18	350	500
12	½	¾-16	350	500
14	5/8	7/8-14	350	500
15	5/8	7/8-14	350	500
16	5/8	7/8-14	350	500
18	¾	1 1/16-12	350	500
20	¾	1 1/16-12	350	500
22	7/8	1 3/16-12	280	400
25	1	1 5/16-12	280	400
30	1 ¼	1 5/8-12	210	315
32	1 ¼	1 5/8-12	210	315
38	1 1/2	1 7/8-12	140	210

101000

Врезное кольцо
JIC 74° (SAE J514)
СТАЛЬ

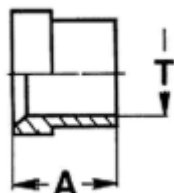

Артикул Сталь	Труба, мм D	Размеры, мм	
		A	
A101000-06	6	10,5	
A101000-08	8	11,5	
A101000-10	10	12,5	
A101000-12	12	14,5	
A101000-14	14	16,5	
A101000-15	15	16,5	
A101000-16	16	16,5	
A101000-18	18	17	
A101000-20	20	17	
A101000-22	22	19	
A101000-25	25	19,5	
A101000-30	30	23	
A101000-32	32	23	
A101000-38	38	28,5	

101011

Гайка
JIC 74° (SAE J514)
СТАЛЬ

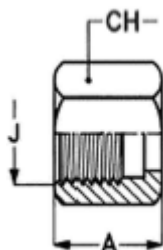

Артикул Сталь	Труба, мм D	Резьба J (UNF)	Размеры, мм	
			A	CH
A101011-06	6	7/16-20	15,5	14
A101011-08	8	½-20	17	16
A101011-10	10	9/16-18	18,5	17
A101011-12	12	¾-16	21,5	22
A101011-16	16	7/8-14	24,5	27
A101011-18	18	1 1/16-12	26	32
A101011-20	20	1 1/16-12	26	32
A101011-22	22	1 3/16-12	27,5	36
A101011-25	25	1 5/16-12	28,5	38
A101011-32	32	1 5/8-12	31	50
A101011-38	38	1 7/8-12	36	57

101022
АДАПТЕР JIC 74°
(SAE J514)
СТАЛЬ

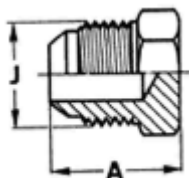

Артикул Сталь	Резьба J (UNF)	Размеры, мм	
		А	
A101022-06	7/16-20	20,5	
A101022-08	1/2-20	20,5	
A101022-10	9/16-18	21,5	
A101022-12	3/4-16	24,5	
A101022-16	7/8-14	28	
A101022-20	1 1/16-12	32,5	
A101022-22	1 3/16-12	33	
A101022-25	1 5/16-12	34	
A101022-32	1 5/8-12	37	
A101022-38	1 7/8-12	42	

101033
АДАПТЕР JIC 74°
(SAE J514)
СТАЛЬ

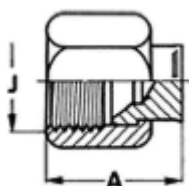

Артикул Сталь	Резьба J (UNF)	Размеры, мм	
		А	
A101033-06	7/16-20	18	
A101033-08	1/2-20	20	
A101033-10	9/16-18	22	
A101033-12	3/4-16	24	
A101033-16	7/8-14	27	
A101033-20	1 1/16-12	30	
A101033-22	1 3/16-12	30	
A101033-25	1 5/16-12	31,5	
A101033-32	1 5/8-12	33	
A101033-38	1 7/8-12	39	

102001
АДАПТЕР JIC 74°
(SAE J514)
СТАЛЬ

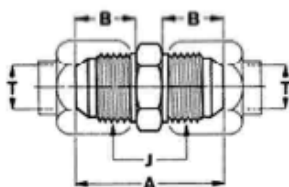

Артикул Сталь	Резьба J (UNF)	Размеры, мм	
		А	В
A102001-06	7/16-20	34,5	14
A102001-08	1/2-20	34,5	14
A102001-10	9/16-18	35,5	14
A102001-12	3/4-16	41	17
A102001-16	7/8-14	47,5	19,5
A102001-20	1 1/16-12	55	22
A102001-22	1 3/16-12	56	22,5
A102001-25	1 5/16-12	57	23
A102001-32	1 5/8-12	61,5	24,5
A102001-38	1 7/8-12	69,5	27,5

102012

**Адаптер
JIC/UNF (SAE
J514)
СТАЛЬ**

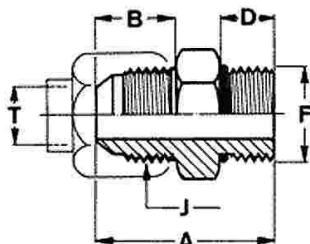

Артикул Сталь	Резьба		Размеры, мм		
	J (UNF)	F (UNF-UN)	A	B	D
A102012-0611	7/16-20	7/16-20	31	14	9,5
A102012-0612	7/16-20	1/2-20	31	14	9,5
A102012-0614	7/16-20	9/16-18	33	14	10
A102012-0812	1/2-20	1/2-20	31	14	9,5
A102012-1014	9/16-18	9/16-18	33	14	10
A102012-1019	9/16-18	3/4-16	34,5	14	11,5
A102012-1219	3/4-16	3/4-16	37,5	17	11,5
A102012-1222	3/4-16	7/8-14	40,5	17	13
A102012-1227	3/4-16	1 1/16-12	45	17	15,5
A102012-1619	7/8-14	3/4-16	40,5	19,5	11,5
A102012-1622	7/8-14	7/8-14	43	19,5	13
A102012-1627	7/8-14	1 1/16-12	47,5	19,5	15,5
A102012-2019	1 1/16-12	3/4-16	45	22	11,5
A102012-2022	1 1/16-12	7/8-14	46,5	22	13
A102012-2027	1 1/16-12	1 1/16-12	50	22	15,5
A102012-2033	1 1/16-12	1 5/16-12	51	22	15,5
A102012-2230	1 3/16-12-12	1 3/16-12	50,5	22,5	15,5
A102012-2527	1 5/16-12	1 1/16-12	51	23	15,5
A102012-2533	1 5/16-12	1 5/16-12	52	23	15,5
A102012-2541	1 5/16-12	1 5/8-12	53,5	23	15,5
A102012-3241	1 5/8-12	1 5/8-12	55	24,5	15,5
A102012-3848	1 7/8-12	1 7/8-12	60	27,5	15,5

102023

**Адаптер
JIC /BSP (ISO
1179-3)
СТАЛЬ**

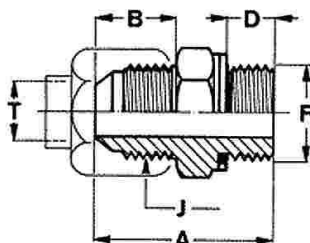

Артикул Сталь	Резьба		Размеры, мм		
	J (UNF)	F (BSPP)	A	B	D
A102023-0610	7/16-20	1/8	29	14	7
A102023-0613	7/16-20	1/4	34,5	14	10
A102023-0617	7/16-20	3/8	34,5	14	10
A102023-0621	7/16-20	1/2	38	14	12
A102023-0810	1/2-20	1/8	29	14	7
A102023-0813	1/2-20	1/4	34,5	14	10
A102023-0817	1/2-20	3/8	34,5	14	10
A102023-1013	9/16-18	1/4	34,5	14	10
A102023-1017	9/16-18	3/8	34,5	14	10
A102023-1021	9/16-18	1/2	38	14	12
A102023-1213	3/4-16	1/4	37,5	17	10
A102023-1217	3/4-16	3/8	37,5	17	10
A102023-1221	3/4-16	1/2	41	17	12
A102023-1226	3/4-16	3/4	45	17	14
A102023-1617	7/8-14	3/8	40,5	19,5	10
A102023-1621	7/8-14	1/2	43,5	19,5	12
A102023-1626	7/8-14	3/4	47,5	19,5	14
A102023-2021	1 1/16-12	1/2	47	22	12
A102023-2026	1 1/16-12	3/4	50	22	14
A102023-2033	1 1/16-12	1	52,5	22	15,5
A102023-2226	1 3/16-12	3/4	50,5	22,5	14
A102023-2526	1 5/16-12	3/4	51	23	14
A102023-2533	1 5/16-12	1	53,5	23	15,5
A102023-2542	1 5/16-12	1 1/4	57	23	17,5
A102023-3233	1 5/8-12	1	55,5	24,5	15,5
A102023-3242	1 5/8-12	1 1/4	58,5	24,5	17,5
A102023-3842	1 7/8-12	1 1/4	61,5	27,5	17,5
A102023-3848	1 7/8-12	1 1/2	65,5	27,5	19,5

102067
АДАПТЕР JIC /M
(SAE J514) (ISO 6149)
СТАЛЬ

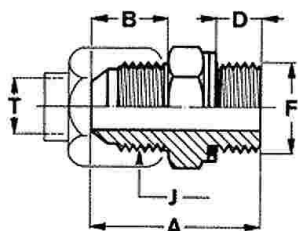

Артикул Сталь	Резьба		Размеры, мм		
	J (UNF)	F (METRIC)	A	B	D
A102067-0610	7/16-20	10X1	30	14	8
A102067-0612	7/16-20	12X1,5	33	14	9,5
A102067-0810	1/2-20	10X1	30	14	8
A102067-0812	1/2-20	12X1,5	33	14	9,5
A102067-0814	1/2-20	14X1,5	34	14	9,5
A102067-1014	9/16-18	14X1,5	34	14	9,5
A102067-1016	9/16-18	16X1,5	35	14	11
A102067-1216	3/4-16	16X1,5	38	17	11
A102067-1218	3/4-16	18X1,5	39,5	17	12
A102067-1618	7/8-14	18X1,5	42	19,5	12
A102067-1620	7/8-14	20X1,5	43	19,5	12
A102067-1622	7/8-14	22X1,5	44,5	19,5	13,5
A102067-2022	1 1/16-12	22X1,5	48	22	13,5
A102067-2027	1 1/16-12	27X2	52	22	16
A102067-2226	1 3/16-12	26X1,5	49	22,5	13,5
A102067-2527	1 5/16-12	27X2	53	23	16
A102067-2533	1 5/16-12	33X2	54	23	16
A102067-3242	1 5/8-12	42X2	58	24,5	16,5
A102067-3848	1 7/8-12	48X2	65,5	27,5	19,5

102100
АДАПТЕР JIC 74°/
NPTF (SAE J514)
СТАЛЬ

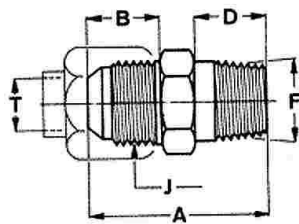

Артикул Сталь	Резьба		Размеры, мм		
	J (UNF)	F (NPTF)	A	B	D
A102100-0610	7/16-20	1/8	31	14	10
A102100-0613	7/16-20	1/4	35,5	14	14,5
A102100-0810	1/2-20	1/8	31	14	10
A102100-0813	1/2-20	1/4	35,5	14	14,5
A102100-1010	1/2-20	1/8	31,5	14	10
A102100-1013	9/16-18	1/4	36	14	14,5
A102100-1017	9/16-18	3/8	36	14	14,5
A102100-1021	9/16-18	1/2	42,5	14	19
A102100-1213	3/4-16	1/4	39	17	14,5
A102100-1217	3/4-16	3/8	39	17	14,5
A102100-1221	3/4-16	1/2	45,5	17	19
A102100-1226	3/4-16	3/4	47,5	17	19
A102100-1617	7/8-14	3/8	43,5	19,5	14,5
A102100-1621	7/8-14	1/2	48	19,5	19
A102100-1626	7/8-14	3/4	50	19,5	19
A102100-2021	1 1/16-12	1/2	52,5	22	19
A102100-2026	1 1/16-12	3/4	52,5	22	19
A102100-2033	1 1/16-12	1	57	22	24
A102100-2226	1 3/16-12	3/4	53	22,5	19
A102100-2526	1 5/16-12	3/4	53,5	23	19
A102100-2533	1 5/16-12	1	58,5	23	24
A102100-3233	1 5/8-12	1	61,5	24,5	24
A102100-3242	1 5/8-12	1 1/4	62	24,5	24,5
A102100-3842	1 7/8-12	1 1/4	67	27,5	24,5
A102100-3848	1 7/8-12	1 1/2	68	27,5	25,5

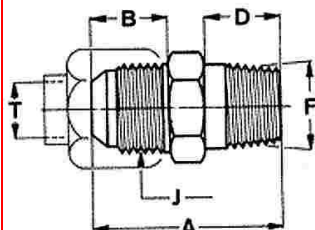
102111
Адаптер
JIC/BSP (SAE J514)
(ISO 7-PT)
СТАЛЬ

Артикул Сталь	Резьба		Размеры, мм		
	J (UNF)	F (BSPT)	A	B	D
A102111-0610	7/16-20	1/8	29	14	8
A102111-0613	7/16-20	1/4	33	14	12
A102111-0810	1/2-20	1/8	29	14	8
A102111-0813	1/2-20	1/4	33	14	12
A102111-1013	9/16-18	1/4	33,5	14	12
A102111-1017	9/16-18	3/8	33,5	14	12
A102111-1021	9/16-18	1/2	37,5	14	14
A102111-1213	3/4-16	1/4	36,5	17	12
A102111-1217	3/4-16	3/8	36,5	17	12
A102111-1221	3/4-16	1/2	40,5	17	14
A102111-1617	7/8-14	3/8	41	19,5	12
A102111-1621	7/8-14	1/2	43	19,5	14
A102111-1626	7/8-14	3/4	47	19,5	16
A102111-2021	1 1/16-12	1/2	47,5	22	14
A102111-2026	1 1/16-12	3/4	49,5	22	16
A102111-2033	1 1/16-12	1	51,5	22	18
A102111-2226	1 3/16-12	3/4	50	22,5	16
A102111-2526	1 5/16-12	3/4	50,5	23	16
A102111-2533	1 5/16-12	1	52,5	23	18
A102111-3233	1 5/8-12	1	55,5	24,5	18
A102111-3242	1 5/8-12	1 1/4	57,5	24,5	20
A102111-3848	1 7/8-12	1 1/2	62,5	27,5	20

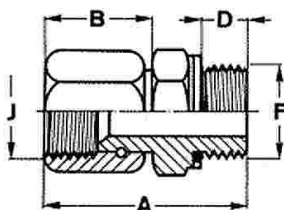
102177
Адаптер
JIC /BSP (SAE
J514) (ISO 1179-3)
СТАЛЬ

Артикул Сталь	Резьба		Размеры, мм		
	J (UNF)	F (BSPP)	A	B	D
A102177-0610	7/16-20	1/8	33,5	18,5	7
A102177-0613	7/16-20	1/4	39	18,5	10
A102177-0617	7/16-20	3/8	39	18,5	10
A102177-0813	1/2-20	1/4	41	20,5	10
A102177-0817	1/2-20	3/8	41	20,5	10
A102177-1013	9/16-18	1/4	42	21,5	10
A102177-1017	9/16-18	3/8	42	21,5	10
A102177-1021	9/16-18	1/2	45,5	21,5	12
A102177-1213	3/4-16	1/4	43,5	23	10
A102177-1217	3/4-16	3/8	43,5	23	10
A102177-1221	3/4-16	1/2	47	23	12
A102177-1617	7/8-14	3/8	47	26	10
A102177-1621	7/8-14	1/2	50	26	12
A102177-1626	7/8-14	3/4	54	26	14
A102177-2021	1 1/16-12	1/2	52,5	27,5	12
A102177-2026	1 1/16-12	3/4	55,5	27,5	14
A102177-2033	1 1/16-12	1	58	27,5	15,5
A102177-2526	1 5/16-12	3/4	58	30	14
A102177-2533	1 5/16-12	1	60,5	30	15,5
A102177-2542	1 5/16-12	1 1/4	64	30	17,5
A102177-3233	1 5/8-12	1	64	33	15,5
A102177-3242	1 5/8-12	1 1/4	67	33	17,5
A102177-3842	1 7/8-12	1 1/4	72	38	17,5
A102177-3848	1 7/8-12	1 1/2	76	38	19,5

102209
АДАПТЕР JIS / M
(SAE J514) (ISO 6149)
СТАЛЬ

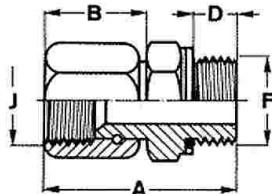

Артикул Сталь	Резьба		Размеры, мм		
	J (UNF)	F (METRIC)	A	B	D
A102209-0610	7/16-20	10X1	34,5	18,5	8
A102209-0612	7/16-20	12X1,5	36,5	18,5	9,5
A102209-0810	1/2-20	10X1	36,5	20,5	8
A102209-0812	1/2-20	12X1,5	39	20,5	9,5
A102209-0814	1/2-20	14X1,5	40	20,5	9,5
A102209-1014	9/16-18	14X1,5	41	21,5	9,5
A102209-1016	9/16-18	16X1,5	42,5	21,5	11
A102209-1216	3/4-16	16X1,5	44	23	11
A102209-1218	3/4-16	18X1,5	45,5	23	12
A102209-1618	7/8-14	18X1,5	48,5	26	12
A102209-1620	7/8-14	20X1,5	49,5	26	12
A102209-1622	7/8-14	22X1,5	51	26	13,5
A102209-2022	1 1/16-12	22X1,5	53,5	27,5	13,5
A102209-2027	1 1/16-12	27X2	57,5	27,5	16
A102209-2226	1 3/16-12	26X1,5	55,5	29	13,5
A102209-2527	1 5/16-12	27X2	60	30	16
A102209-2533	1 5/16-12	33X2	61	30	16
A102209-3242	1 5/8-12	42X2	66	33	16,5
A102209-3848	1 7/8-12	48X2	76	38	19,5

102144
АДАПТЕР JIS / BSP
60° (ISO 228-PF)(SAE
J514)
СТАЛЬ

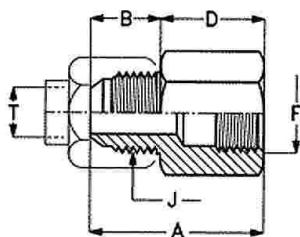

Артикул Сталь	Резьба		Размеры, мм		
	J (UNF)	F (BSP)	A	B	D
A102144-0610	7/16-20	1/8	30	14	16
A102144-0613	7/16-20	1/4	35,5	14	21,5
A102144-0810	1/2-20	1/8	30	14	16
A102144-0813	1/2-20	1/4	35,5	14	21,5
A102144-1013	9/16-18	1/4	35,5	14	21,5
A102144-1017	9/16-18	3/8	36,5	14	22,5
A102144-1021	9/16-18	1/2	42,5	14	28,5
A102144-1213	3/4-16	1/4	38,5	17	21,5
A102144-1217	3/4-16	3/8	39,5	17	22,5
A102144-1221	3/4-16	1/2	45,5	17	28,5
A102144-1621	7/8-14	1/2	48	19,5	28,5
A102144-2021	1 1/16-12	1/2	50,5	22	28,5
A102144-2026	1 1/16-12	3/4	52,5	22	30,5
A102144-2226	1 3/16-12	3/4	53	22,5	30,5
A102144-2533	1 5/16-12	1	59,5	23	36,5
A102144-3233	1 5/8-12	1	61	24,5	36,5
A102144-3242	1 5/8-12	1 1/4	63	24,5	38,5
A102144-3842	1 7/8-12	1 1/4	66	27,5	38,5
A102144-3848	1 7/8-12	1 1/2	66,5	27,5	39

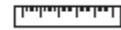
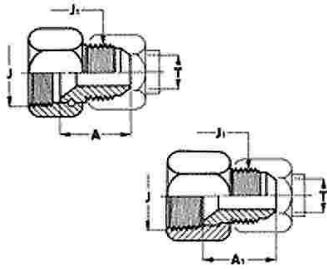
102265
**Адаптер
JIC 74° (SAE J514)**
СТАЛЬ

Артикул Сталь	Резьба		Размеры, мм		
	J (UNF)	J1 (UNF)	A	A1	
A102265-1006	9/16-18	7/16-20	-	24,5	
A102265-1008	9/16-18	1/2-20	24,5	-	
A102265-1206	3/4-16	7/16-20	-	25,5	
A102265-1208	3/4-16	1/2-20	-	25,5	
A102265-1210	3/4-16	9/16-18	-	25,5	
A102265-1606	7/8-14	7/16-20	-	26	
A102265-1610	7/8-14	9/16-18	-	26	
A102265-1612	7/8-14	3/4-16	29	-	
A102265-2006	1 1/16-12	7/16-20	-	27,5	
A102265-2010	1 1/16-12	9/16-18	-	27,5	
A102265-2012	1 1/16-12	3/4-16	-	30,5	
A102265-2016	1 1/16-12	7/8-14	31	-	
A102265-2220	1 3/16-12	1 1/16-12	34	-	
A102265-2520	1 5/16-12	1 1/16-12	-	37,5	
A102265-2522	1 5/16-12	1 3/16-12	35,5	-	
A102265-3220	1 5/8-12	1 1/16-12	-	39	
A102265-3222	1 5/8-12	1 3/16-12	-	39,5	
A102265-3225	1 5/8-12	1 5/16-12	-	40	
A102265-3832	1 7/8-12	1 5/8-12	-	43	

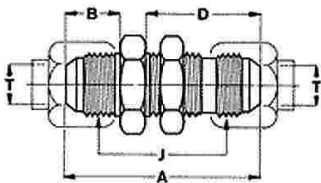
103002
**Адаптер
JIC 74°(SAE J514)**
СТАЛЬ

Артикул Сталь	Резьба	Размеры, мм		
	J (UNF)	A	B	D
A103002-06	7/16-20	52,5	14	31,5
A103002-08	1/2-20	52,5	14	31,5
A103002-10	9/16-18	55,5	14	33,5
A103002-12	3/4-16	62	17	37,5
A103002-16	7/8-14	69,5	19,5	41
A103002-20	1 1/16-12	78,5	22	45,5
A103002-22	1 3/16-12	79	22,5	45,5
A103002-25	1 5/16-12	80	23	45,5
A103002-32	1 5/8-12	84	24,5	46,5
A103002-38	1 7/8-12	89,5	27,5	47

105015
45° АДАПТЕР JIC
/UNF
(SAE J514)
СТАЛЬ

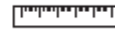
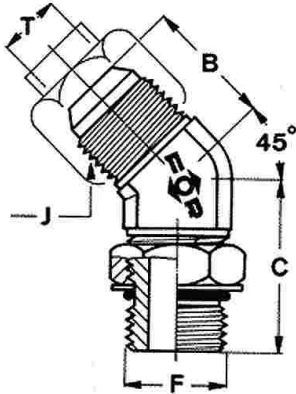

Артикул Сталь	Резьба		Размеры, мм	
	J (UNF)	F (UNF-UN)	B	C
A105015-0611	7/16-20	7/16-20	18	26,5
A105015-0612	7/16-20	1/2-20	19,5	26,5
A105015-0812	1/2-20	1/2-20	19,5	26,5
A105015-1014	9/16-18	9/16-18	21	29
A105015-1019	9/16-18	3/4-16	22	33
A105015-1219	3/4-16	3/4-16	25	33
A105015-1222	3/4-16	7/8-14	25,5	38,5
A105015-1619	7/8-14	1/4-16	28	35
A105015-1622	7/8-14	7/8-14	28	38,5
A105015-2019	1 1/16-12	3/4-16	32,5	37
A105015-2022	1 1/16-12	7/8-14	32,5	40,5
A105015-2027	1 1/16-12	1 1/16-12	32,5	44
A105015-2533	1 5/16-12	1 5/16-12	37	47
A105015-3241	1 5/8-12	1 5/8-12	40,5	48,5
A105015-3848	1 7/8-12	1 7/8-12	45	48,5

105026
45° АДАПТЕР JIC / BSP
(SAE J514) (ISO 1179-3)
СТАЛЬ

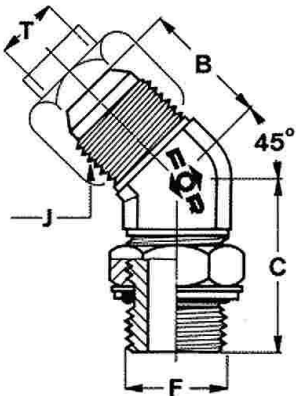

Артикул Сталь	Резьба		Размеры, мм	
	J (UNF)	F (BSPP)	B	C
A105026-0610	7/16-20	1/8	18	26,5
A105026-0613	7/16-20	1/4	21	29
A105026-0617	7/16-20	3/8	22	33
A105026-0621	7/16-20	3/8	22,5	38,5
A105026-0810	1/2-20	3/8	19,5	26,5
A105026-0813	1/2-20	1/4	21	29
A105026-0817	1/2-20	3/8	22	33
A105026-1013	9/16-18	1/4	21	29
A105026-1017	9/16-18	3/8	22	33
A105026-1021	9/16-18	1/2	22,5	38,5
A105026-1213	3/4-16	1/4	25	30
A105026-1217	3/4-16	3/8	25	33
A105026-1221	3/4-16	1/2	25,5	38,5
A105026-1226	3/4-16	3/4	27,5	44
A105026-1617	7/8-14	3/8	28	35
A105026-1621	7/8-14	1/2	28	38,5
A105026-1626	7/8-14	3/4	30	44
A105026-2021	1 1/16-12	1/2	32,5	40,5
A105026-2026	1 1/16-12	3/4	32,5	44
A105026-2533	1 5/16-12	1	37	47
A105026-3848	1 7/8-12	1 1/2	45	48,5

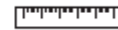
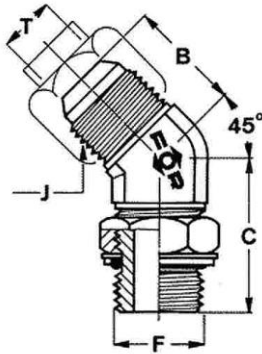
105037
**Адаптер 45°
JIC/M (SAE J514)
(ISO 6149)**

Артикул Сталь	Резьба		Размеры, мм		
	J (UNF)	F (метрическая резьба)	B	C	
A105037-0610	7/16-20	10x1	18	26,5	
A105037-0612	7/16-20	12x1,5	21	29	
A105037-0810	1/2-20	10x1	19,5	26,5	
A105037-0812	1/2-20	12x1,5	21	29	
A105037-0814	1/2-20	14x1,5	21	29	
A105037-1014	9/16-18	14x1,5	21	29	
A105037-1016	9/16-18	16x1,5	22	33	
A105037-1216	3/4-16	16x1,5	25	33	
A105037-1218	3/4-16	18x1,5	25	33	
A105037-1618	7/8-14	18x1,5	28	35	
A105037-1620	7/8-14	20x1,5	28	38,5	
A105037-1622	7/8-14	22x1,5	28	38,5	
A105037-2022	1 1/16-12	22x1,5	32,5	40,5	
A105037-2027	1 1/16-12	27x2	32,5	44	
A105037-2527	1 5/16-12	27x2	37	47	
A105037-2533	1 5/16-12	33x2	37	47	

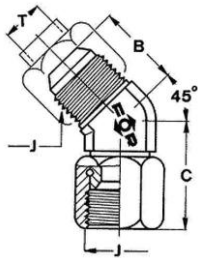
105004
**Адаптер 45°
JIC (SAE J514)
СТАЛЬ**

Артикул Сталь	Резьба		Размеры, мм		
	J (UNF)		B	C	
A105004-06	7/16-20		18	24,5	
A105004-08	1/2-20		19,5	26,5	
A105004-10	9/16-18		21	28,5	
A105004-12	3/4-16		25	32	
A105004-16	7/8-14		28	37	
A105004-20	1 1/16-12		32,5	38,5	
A105004-25	1 5/16-12		37	45	
A105004-32	1 5/8-12		40,5	51,5	
A105004-38	1 7/8-12		45	57,5	

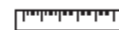
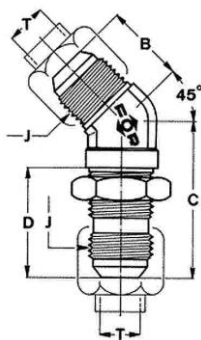
106005
**Адаптер 45°
JIC (SAE J514)
СТАЛЬ**

Артикул Сталь	Резьба		Размеры, мм		
	J (UNF)		B	C	D
A106005-06	7/16-20		18	39	28,5
A106005-08	1/2-20		19,5	39	28,5
A106005-10	9/16-18		21	42,5	30
A106005-12	3/4-16		25	49	35
A106005-16	7/8-14		28	55	38,5
A106005-20	1 1/16-12		32,5	62	42,5
A106005-25	1 5/16-12		37	65	42,5
A106005-32	1 5/8-12		40,5	67	44
A106005-38	1 7/8-12		45	67,5	44

107006
90° АДАПТЕР JIC
(SAE J514)
СТАЛЬ

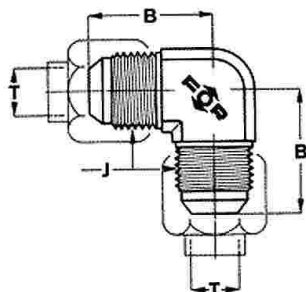

Артикул Сталь	Резьба		Размеры, мм		
	J (UNF)		B		
A107006-06	7/16-20		22,5		
A107006-08	1/2-20		24		
A107006-10	9/16-18		27		
A107006-12	3/4-16		31,5		
A107006-16	7/8-14		36,5		
A107006-20	1 1/16-12		42		
A107006-25	1 5/16-12		46		
A107006-32	1 5/8-12		52		
A107006-38	1 7/8-12		59		

107062
90° АДАПТЕР JIC / BSP
(SAE J514) (ISO 7-PT)
СТАЛЬ

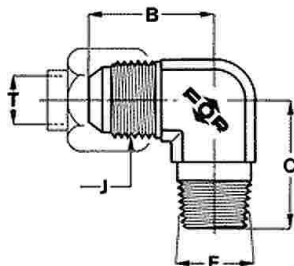

Артикул Сталь	Резьба		Размеры, мм		
	J (UNF)	F (BSPT)	B	C	
A107062-0610	7/16-20	1/8	22,5	19,5	
A107062-0613	7/16-20	1/4	27	27,5	
A107062-0810	1/2-20	1/8	24	19,5	
A107062-0813	1/2-20	1/4	27	27,5	
A107062-1013	9/16-18	1/4	27	27,5	
A107062-1017	9/16-18	3/8	28,5	31	
A107062-1021	9/16-18	1/2	31	37	
A107062-1213	3/4-16	1/4	31,5	31	
A107062-1217	3/4-16	3/8	31,5	31	
A107062-1221	3/4-16	1/2	34	37	
A107062-1617	7/8-14	3/8	36,5	32	
A107062-1621	7/8-14	1/2	36,5	37	
A107062-1626	7/8-14	3/4	39,5	40,5	
A107062-2021	1 1/16-12	1/2	42	40,5	
A107062-2026	1 1/16-12	3/4	42	40,5	
A107062-2033	1 1/16-12	1	45	50	
A107062-2526	1 5/16-12	3/4	46	45	
A107062-2533	1 5/16-12	1	46	50	
A107062-3233	1 5/8-12	1	52	59	
A107062-3242	1 5/8-12	1 1/4	52	60	
A107062-3848	1 7/8-12	1 1/2	59	67	

107051

Адаптер 90°
JIC 74°/NPTF
(SAE J514)
СТАЛЬ

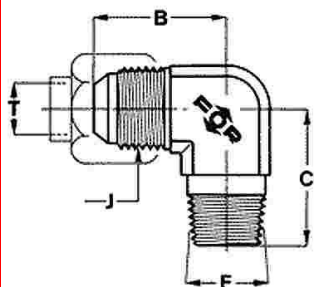

Артикул Сталь	Резьба		Размеры, мм		
	J (UNF)	F (NPTF)	B	C	
A107051-0610	7/16-20	1/8	22,5	19,5	
A107051-0613	7/16-20	1/4	27	27,5	
A107051-0810	1/2-20	1/8	24	19,5	
A107051-0813	1/2-20	1/4	27	27,5	
A107051-1010	1/2-20	1/8	27	23,5	
A107051-1013	9/16-18	1/4	27	27,5	
A107051-1017	9/16-18	3/8	28,5	31	
A107051-1021	9/16-18	1/2	31	37	
A107051-1213	3/4-16	1/4	31,5	31	
A107051-1217	3/4-16	3/8	31,5	31	
A107051-1221	3/4-16	1/2	34	37	
A107051-1226	3/4-16	3/4	37	40,5	
A107051-1617	7/8-14	3/8	36,5	32	
A107051-1621	7/8-14	1/2	36,5	37	
A107051-1626	7/8-14	3/4	39,5	40,5	
A107051-2021	1 1/16-12	1/2	42	40,5	
A107051-2026	1 1/16-12	3/4	42	40,5	
A107051-2526	1 5/16-12	3/4	46	45	
A107051-2533	1 5/16-12	1	46	50	
A107051-3233	1 5/8-12	1	52	59	
A107051-3242	1 5/8-12	1 1/4	52	60	
A107051-3848	1 7/8-12	1 1/2	59	67	

107039

Адаптер 90°
JIC/BSP (SAE J514)
(ISO 1179-3)
СТАЛЬ

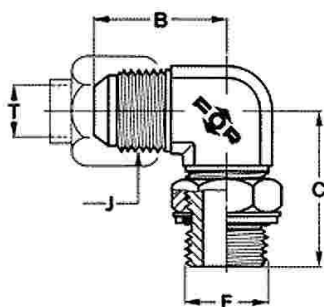

Артикул Сталь	Резьба		Размеры, мм		
	J (UNF)	F (BSPP)	B	C	
A107039-0610	7/16-20	1/8	22,5	26	
A107039-0613	7/16-20	1/4	27	31,5	
A107039-0617	7/16-20	3/8	28,5	36,5	
A107039-0621	7/16-20	3/8	31	43	
A107039-0810	1/2-20	1/8	24	27,5	
A107039-0813	1/2-20	1/4	27	31,5	
A107039-0817	1/2-20	3/8	28,5	36,5	
A107039-1013	9/16-18	1/4	27	31,5	
A107039-1017	9/16-18	3/8	28,5	36,5	
A107039-1021	9/16-18	1/2	31	43	
A107039-1213	3/4-16	1/4	31,5	33,5	
A107039-1217	3/4-16	3/8	31,5	36,5	
A107039-1221	3/4-16	1/2	34	43	
A107039-1226	3/4-16	3/4	37	49	
A107039-1617	7/8-14	3/8	36,5	39,5	
A107039-1621	7/8-14	1/2	36,5	43	
A107039-1627	7/8-14	3/4	39,5	49	
A107039-2021	1 1/16-12	1/2	42	45,5	
A107039-2026	1 1/16-12	3/4	42	49	
A107039-2033	1 1/16-12	1	44,5	52	
A107039-2226	1 3/16-12	3/4	44	50,5	
A107039-2526	1 5/16-12	3/4	46	52	
A107039-2533	1 5/16-12	1	46	52	
A107039-2542	1 5/16-12	1 1/4	51	57	
A107039-3233	1 5/8-12	1	52	57	
A107039-3242	1 5/8-12	1 1/4	52	57	
A107039-3842	1 7/8-12	1 1/4	59	61	
A107039-3848	1 7/8-12	1 1/2	59	61	

107040
90° АДАПТЕР JIC / M
(SAE J514)(ISO 6149)
СТАЛЬ

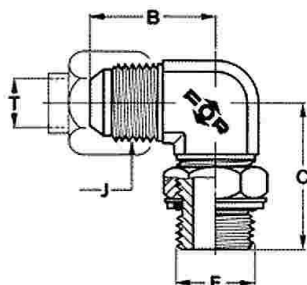

Артикул Сталь	Резьба		Размеры, мм		
	J (UNF)	F (метрическая резьба)	B	C	
A107040-0610	7/16-20	10x1	22,5	27,5	
A107040-0612	7/16-20	12x1,5	27	31,5	
A107040-0810	1/2-20	10x1	24	27,5	
A107040-0812	1/2-20	12x1,5	27	31,5	
A107040-0814	1/2-20	14x1,5	27	32,5	
A107040-1014	9/16-18	14x1,5	27	32,5	
A107040-1016	9/16-18	16x1,5	28,5	36,5	
A107040-1216	3/4-16	16x1,5	31,5	36,5	
A107040-1218	3/4-16	18x1,5	31,5	39,5	
A107040-1618	7/8-14	18x1,5	36,5	41,5	
A107040-1620	7/8-14	20x1,5	36,5	43	
A107040-1622	7/8-14	22x1,5	36,5	43	
A107040-2022	1 1/16-12	22x1,5	42	45,5	
A107040-2027	1 1/16-12	27x2	42	51,5	
A107040-2226	1 3/16-12	26x1,5	44	50,5	
A107040-2527	1 5/16-12	27x2	46	55	
A107040-2533	1 5/16-12	33x2	46	55	
A107040-3242	1 5/8-12	42x2	52	60	
A107040-3848	1 7/8-12	48x2	59	67	

107028
90° АДАПТЕР JIC /
UNF
(SAE J514) (ISO 7-PT)
СТАЛЬ

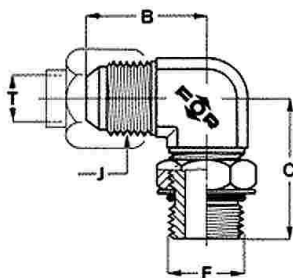

Артикул Сталь	Резьба		Размеры, мм		
	J (UNF)	F (UNF-UN)	B	C	
A107028-0611	7/16-20	7/16-20	22,5	26	
A107028-0612	7/16-20	1/2-20	24	27,5	
A107028-0614	7/16-20	9/16-18	27	31,5	
A107028-0812	1/2-20	1/2-20	24	27,5	
A107028-1014	9/16-18	9/16-18	27	31,5	
A107028-1019	9/16-18	3/4-16	28,5	36,5	
A107028-1219	3/4-16	3/4-16	31,5	36,5	
A107028-1222	3/4-16	7/8-14	34	43	
A107028-1227	3/4-16	1 1/16-12	37	49	
A107028-1619	7/8-14	3/4-16	36,5	39,5	
A107028-1622	7/8-14	7/8-14	36,5	43	
A107028-1627	7/8-14	1 1/16-12	39,5	49	
A107028-2019	1 1/16-12	3/4-16	42	42	
A107028-2022	1 1/16-12	7/8-14	42	45,5	
A107028-2027	1 1/16-12	1 1/16-12	42	49	
A107028-2033	1 1/16-12	1 5/16-12	44,5	52	
A107028-2527	1 5/16-12	1 1/16-12	46	52	
A107028-2533	1 5/16-12	1 5/16-12	46	52	
A107028-2541	1 5/16-12	1 5/8-12	51	57,5	
A107028-3241	1 5/8-12	1 5/8-12	52	57,5	
A107028-3848	1 7/8-12	1 7/8-12	59	61	

107017
Адаптер 90°
JIC (SAE J514)
СТАЛЬ

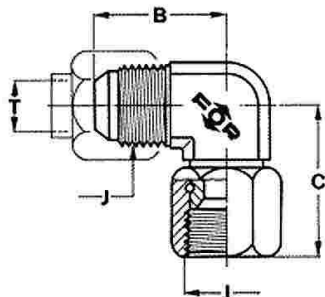

Артикул Сталь	Резьба	Размеры, мм		
	J (UNF)	B	C	
A107017-06	7/16-20	22,5	26	
A107017-08	1/2-20	24	28	
A107017-10	9/16-18	27	31	
A107017-12	3/4-16	31,5	35,5	
A107017-16	7/8-14	36,5	42	
A107017-20	1 1/16-12	42	45,5	
A107017-25	1 5/16-12	46	51,5	
A107017-32	1 5/8-12	52	59	
A107017-38	1 7/8-12	59	67	

108007
Адаптер 90°
JIC (SAE J514)
СТАЛЬ

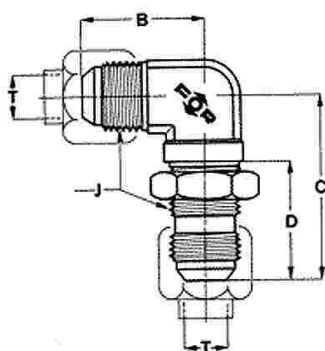

Артикул Сталь	Резьба	Размеры, мм		
	J (UNF)	B	C	D
A108007-06	7/16-20	24,5	40,5	28,5
A108007-08	1/2-20	26	41	28,5
A108007-10	9/16-18	27,5	46	30
A108007-12	3/4-16	34,5	53,5	35
A108007-16	7/8-14	39,5	60,5	38,5
A108007-20	1 1/16-12	45	68	42,5
A108007-25	1 5/16-12	49	71	42,5
A108007-32	1 5/8-12	55	79	44
A108007-38	1 7/8-12	59	87	44

111001
T - АДАПТЕР JIC
(SAE J514)
СТАЛЬ

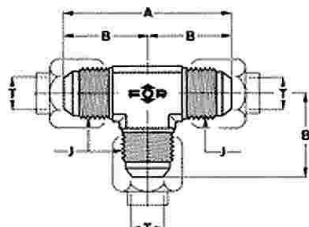

Артикул Сталь	Резьба	Размеры, мм	
	J (UNF)	A	B
A111001-06	7/16-20	45	22,5
A111001-08	1/2-20	48	24
A111001-10	9/16-18	54	27
A111001-12	3/4-16	63	31,5
A111001-16	7/8-14	73	36,5
A111001-20	1 1/16-12	84	42
A111001-25	1 5/16-12	92	46
A111001-32	1 5/8-12	104	52
A111001-38	1 7/8-12	118	59

111023
T - АДАПТЕР JIC / UNF
(SAE J514)
СТАЛЬ

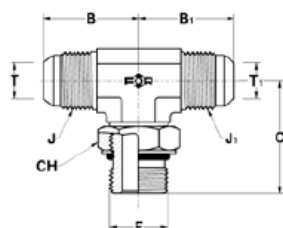

Артикул Сталь	Резьба			Размеры, мм		
	J (UNF)	J1 UNF-UN)	F (UNF-UN)	A	B	C
A111023-0611	7/16-20	7/16-20	7/16-20	45	22,5	26
A111023-0812	1/2-20	1/2-20	1/2-20	48	24	27,5
A111023-1014	9/16-18	9/16-18	9/16-18	54	27	31,5
A111023-1219	3/4-16	3/4-16	3/4-16	63	31,5	36,5
A111023-1622	7/8-14	7/8-14	7/8-14	73	36,5	43
A111023-2027	1 1/16-12	1 1/16-12	1 1/16-12	84	42	49
A111023-2533	1 5/16-12	1 5/16-12	1 5/16-12	92	46	52

111034
Адаптер
JIC /BSP
(SAE J514)
(ISO 1179-3)
СТАЛЬ

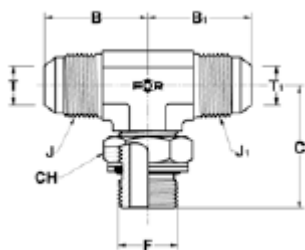

Артикул Сталь	Резьба			Размеры, мм		
	J (UNF)	J1 (UNF-UN)	F (BSP)	A	B	C
A111034-0610	7/16-20	7/16-20	1/8	45	22,5	26
A111034-0613	7/16-20	7/16-20	1/4	54	27	31,5
A111034-0617	7/16-20	7/16-20	3/8	57	28,5	36,5
A111034-0621	7/16-20	7/16-20	3/8	62	31	43
A111034-0810	1/2-20	1/2-20	1/8	48	24	27,5
A111034-0813	1/2-20	1/2-20	1/4	54	27	31,5
A111034-0817	1/2-20	1/2-20	3/8	57	28,5	36,5
A111034-1013	9/16-18	9/16-18	1/4	54	27	31,5
A111034-1017	9/16-18	9/16-18	3/8	57	28,5	36,5
A111034-1021	9/16-18	9/16-18	1/2	62	31	43
A111034-1213	3/4-16	3/4-16	1/4	63	31,5	33,5
A111034-1217	3/4-16	3/4-16	3/8	63	31,5	36,5
A111034-1221	3/4-16	3/4-16	1/2	68	34	43
A111034-1226	3/4-16	3/4-16	3/4	74	37	49
A111034-1617	7/8-14	7/8-14	3/8	73	36,5	39,5
A111034-1621	7/8-14	7/8-14	1/2	73	36,5	43
A111034-1626	7/8-14	7/8-14	3/4	79	39,5	49
A111034-2021	1 1/16-12	1 1/16-12	1/2	84	42	45,5
A111034-2026	1 1/16-12	1 1/16-12	3/4	84	42	49
A111034-2033	1 1/16-12	1 1/16-12	1	89	44,5	52
A111034-2526	1 5/16-12	1 5/16-12	3/4	92	46	52
A111034-2533	1 5/16-12	1 5/16-12	1	92	46	52
A111034-2542	1 5/16-12	1 5/16-12	1 1/4	102	51	57
A111034-3233	1 5/8-12	1 5/8-12	1	104	52	57
A111034-3242	1 5/8-12	1 5/8-12	1 1/4	104	52	57
A111034-3842	1 7/8-12	1 7/8-12	1 1/4	118	59	61
A111034-3848	1 7/8-12	1 7/8-12	1 1/2	118	59	61

111045
Адаптер
JIC/M (SAE J514)
(ISO 6149)
СТАЛЬ

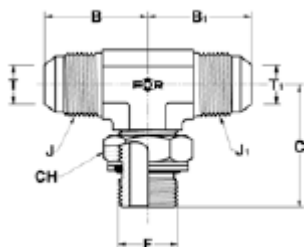

Артикул Сталь	Резьба			Размеры, мм		
	J (UNF)	J1 (UNF-UN)	F (метрическая резьба)	A	B	C
A111045-0610	7/16-20	7/16-20	10x1	45	22,5	27,5
A111045-0612	7/16-20	7/16-20	12x1,5	54	27	31,5
A111045-0812	1/2-20	1/2-20	12x1,5	54	27	31,5
A111045-0814	1/2-20	1/2-20	14x1,5	54	27	32,5
A111045-1014	9/16-18	9/16-18	14x1,5	54	27	32,5
A111045-1016	9/16-18	9/16-18	16x1,5	57	28,5	36,5
A111045-1216	3/4-16	3/4-16	16x1,5	63	31,5	36,5
A111045-1218	3/4-16	3/4-16	18x1,5	63	31,5	39,5
A111045-1618	7/8-14	7/8-14	18x1,5	73	36,5	41,5
A111045-1622	7/8-14	7/8-14	22x1,5	73	36,5	43
A111045-2022	1 1/16-12	1 1/16-12	22x1,5	84	42	45,5
A111045-2027	1 1/16-12	1 1/16-12	27x2	84	42	51,5
A111045-2527	1 5/16-12	1 5/16-12	27x2	92	46	55
A111045-2533	1 5/16-12	1 5/16-12	33x2	92	46	55
A111045-3242	1 5/8-12	1 5/8-12	42x2	104	52	60
A111045-3848	1 7/8-12	1 7/8-12	48x2	118	59	67

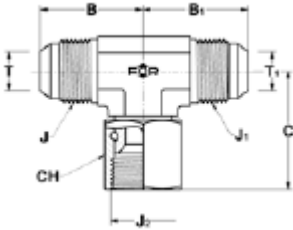
111012
АДАПТЕР JIC
(SAE J514)
СТАЛЬ

Артикул Сталь	Резьба		Размеры, мм		
	J (UNF)	J (UNF-UN)	A	B	C
A111012-06	7/16-20	7/16-20	45	22,5	26
A111012-08	1/2-20	1/2-20	48	24	28
A111012-10	9/16-18	9/16-18	54	27	31
A111012-12	3/4-16	3/4-16	63	31,5	35,5
A111012-16	7/8-14	7/8-14	73	36,5	42
A111012-20	1 1/16-12	1 1/16-12	84	42	45,5
A111012-25	1 5/16-12	1 5/16-12	92	46	51,5
A111012-32	1 5/8-12	1 5/8-12	104	52	59
A111012-38	1 7/8-12	1 7/8-12	118	59	67

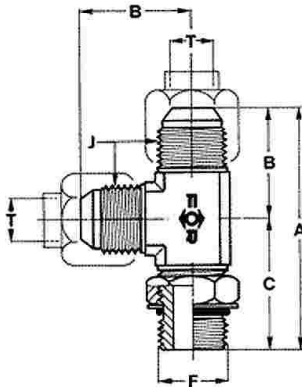
113014
АДАПТЕР JIC / UNF
(SAE J514)
СТАЛЬ

Артикул Сталь	Резьба		Размеры, мм		
	J (UNF)	F (UNF-UN)	A	B	C
A113014-0611	7/16-20	7/16-20	48,5	22,5	26
A113014-0812	1/2-20	1/2-20	51,5	24	27,5
A113014-1014	9/16-18	9/16-18	58,5	27	31,5
A113014-1019	9/16-18	3/4-16	65	28,5	36,5
A113014-1219	3/4-16	3/4-16	68	31,5	36,5
A113014-1622	7/8-14	7/8-14	79,5	36,5	43
A113014-2022	1 1/16-12	7/8-14	87,5	42	45,5
A113014-2027	1 1/16-12	1 1/16-12	91	42	49
A113014-2033	1 1/16-12	1 5/16-12	96,5	44,5	52
A113014-2527	1 5/16-12	1 1/16-12	98	46	52
A113014-2533	1 5/16-12	1 5/16-12	98	46	52
A113014-3241	1 5/8-12	1 5/8-12	109	52	57

113025

**Адаптер
JIC /BSPP
(SAE J514)
(ISO 1179-3)
СТАЛЬ**

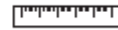
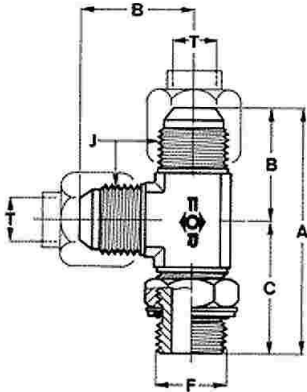

Артикул Сталь	Резьба		Размеры, мм		
	J (UNF)	F (BSPP)	A	B	C
A113025-0610	7/16-20	1/8	48,5	22,5	26
A113025-0613	7/16-20	1/4	58,5	27	31,5
A113025-0617	7/16-20	3/8	65	28,5	36,5
A113025-0810	1/2-20	1/8	51,5	24	27,5
A113025-0813	1/2-20	1/4	58,5	27	31,5
A113025-0817	1/2-20	3/8	65	28,5	36,5
A113025-1013	9/16-18	1/4	58,5	27	31,5
A113025-1017	9/16-18	3/8	65	28,5	36,5
A113025-1021	9/16-18	1/2	74	31	43
A113025-1213	3/4-16	1/4	65	31,5	33,5
A113025-1217	3/4-16	3/8	68	31,5	36,5
A113025-1221	3/4-16	1/2	77	34	43
A113025-1226	3/4-16	3/4	86	37	49
A113025-1617	7/8-14	3/8	76	36,5	39,5
A113025-1621	7/8-14	1/2	79,5	36,5	43
A113025-1626	7/8-14	3/4	88,5	39,5	49
A113025-2021	1 1/16-12	1/2	87,5	42	45,5
A113025-2026	1 1/16-12	3/4	91	42	49
A113025-2033	1 1/16-12	1	96,5	44,5	52
A113025-2526	1 5/16-12	3/4	98	46	52
A113025-2533	1 5/16-12	1	98	46	52
A113025-2542	1 5/16-12	1 1/4	108	51	57
A113025-3233	1 5/8-12	1	109	52	57
A113025-3242	1 5/8-12	1 1/4	109	52	57
A113025-3842	1 7/8-12	1 1/4	120	59	61
A113025-3848	1 7/8-12	1 1/2	120	59	61

113036

**Адаптер
JIC/M (SAE J514)
(ISO 6149)
СТАЛЬ**

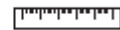
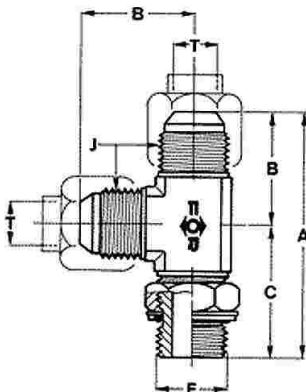

Артикул Сталь	Резьба		Размеры, мм		
	J (UNF)	F (метрическая резьба)	A	B	C
A113036-0610	7/16-20	10x1	48,5	22,5	27,5
A113036-0612	7/16-20	12x1,5	58,5	27	31,5
A113036-0810	1/2-20	10x1	51,5	24	27,5
A113036-0812	1/2-20	12x1,5	58,5	27	31,5
A113036-1014	9/16-18	14x1,5	58,5	27	32,5
A113036-1016	9/16-18	16x1,5	65	28,5	36,5
A113036-1216	3/4-16	16x1,5	68	31,5	36,5
A113036-1218	3/4-16	18x1,5	68	31,5	39,5
A113036-1618	7/8-14	18x1,5	78	36,5	41,5
A113036-1622	7/8-14	22x1,5	79,5	36,5	43
A113036-2027	1 1/16-12	27x2	91	42	51,5
A113036-2527	1 5/16-12	27x2	98	46	55
A113036-2533	1 5/16-12	33x2	98	46	55
A113036-3242	1 5/8-12	42x2	109	52	60
A113036-3848	1 7/8-12	48x2	120	59	67

113003
L - АДАПТЕР JIC
(SAE J514)
СТАЛЬ

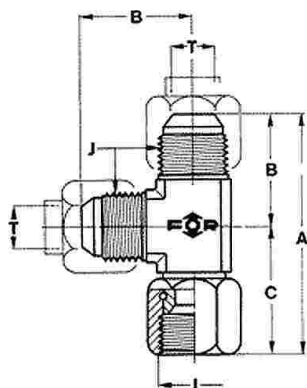

Артикул Сталь	Резьба J (UNF)	Размеры, мм		
		A	B	C
A113003-06	7/16-20	48,5	22,5	26,5
A113003-08	1/2-20	52	24	29
A113003-10	9/16-18	58	27	32
A113003-12	3/4-16	67	31,5	35,5
A113003-16	7/8-14	78,5	36,5	42
A113003-20	1 1/16-12	87,5	42	45,5
A113003-25	1 5/16-12	97,5	46	51,5
A113003-32	1 5/8-12	111	52	59,5
A113003-38	1 7/8-12	126	59	67

501002

Врезное кольцо

ORFS (SAE J1453)

СТАЛЬ

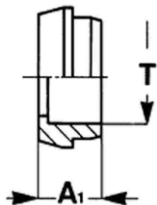

Артикул Сталь	Труба, мм Т	Размеры, мм	
		А1	
A501002-06	6	9,5	
A501002-1008	8	9,5	
A501002-10	10	9,5	
A501002-12	12	9,5	
A501002-1614	14	10,5	
A501002-1615	15	10,5	
A501002-16	16	10,5	
A501002-2018	18	14,0	
A501002-20	20	14,0	
A501002-2522	22	15,5	
A501002-25	25	15,5	
A501002-3228	28	15,5	
A501002-3230	30	15,5	
A501002-32	32	15,5	
A501002-3835	35	15,5	
A501002-38	38	15,5	

501013/501518

Гайка

ORFS (SAE J1453)

СТАЛЬ

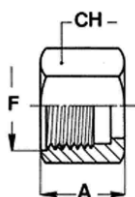

Артикул Сталь	Труба, мм D	Резьба F (UNF)	Размеры, мм	
			A	CH
K501518-06	6	9/16-18	14,5	17
K501013-10	8-10	11/16-16	17,0	22
K501518-12	12	13/16-16	21,0	24
K501013-16	14-16	1-14	23,5	30
K501013-20	18-20	1 3/16-12	26,0	36
K501013-25	22-25	1 7/16-12	28,0	41
K501013-32	28-32	1 11/16-12	28,0	50
K501013-38	35-38	2-12	28,0	57
K501013-06	6	9/16-18	14,5	19
K501013-12	12	13/16-16	21,0	27

501024

Адаптер

ORFS (SAE J1453)

СТАЛЬ

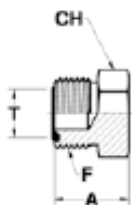

Артикул Сталь	Труба, мм D	Резьба F (UNF)	Размеры, мм	
			A	CH
A501024-06	6	9/16-18	16,5	17
A501024-10	8-10	11/16-16	19	19
A501024-12	12	13/16-16	22	22
A501024-16	14-16	1-14	26	27
A501024-20	18-20	1 3/16-12	27,5	32
A501024-25	22-25	1 7/16-12	28	41
A501024-32	28-32	1 11/16-12	28	46
A501024-38	35-38	2-12	28	55

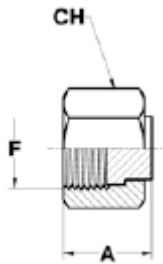
**501035
АДАПТЕР ORFS
(SAE J1453)
СТАЛЬ**

Артикул Сталь	Труба	Резьба	Размеры, мм		
		J (UNF)	A	CH	
A501035-06	6	9/16-18	16	17	
A501035-10	8-10	11/16-16	18	22	
A501035-12	12	13/16-16	22	24	
A501035-16	14-16	1-14	25,5	30	
A501035-20	18-20	1 3/16-12	27	36	
A501035-25	22-25	1 7/16-12	29	41	
A501035-32	28-32	1 11/16-12	29	50	
A501035-38	35-38	2-12	29	60	

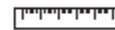
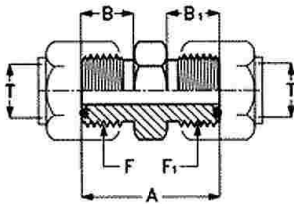
**502003
АДАПТЕР ORFS/
ORFS
СТАЛЬ**

Артикул Сталь	Резьба		Размеры, мм		
	F (UNF)	F1 (UNF)	A	B	B1
A502003-06	9/16-18	9/16-18	27,5	10	10
A502003-10	11/16-16	11/16-16	31	11	11
A502003-1006	11/16-16	11/16-16	29,5	11	10
A502003-12	13/16-16	13/16-16	35,5	13	13
A502003-1210	13/16-16	13/16-16	34	13	11
A502003-16	1-14	1-14	42,5	15,5	15,5
A502003-1612	1-14	1-14	40	15,5	13
A502003-20	1 3/16-12	1 3/16-12	47	17	17
A502003-2016	1 3/16-12	1 3/16-12	45,5	17	15,5
A502003-25	1 7/16-12	1 7/16-12	49	17,5	17,5
A502003-2520	1 7/16-12	1 7/16-12	50	17,5	17
A502003-32	1 11/16-12	1 11/16-12	51	17,5	17,5
A502003-3225	1 11/16-12	1 11/16-12	51	17,5	17,5
A502003-38	2-12	2-12	53	17,5	17,5

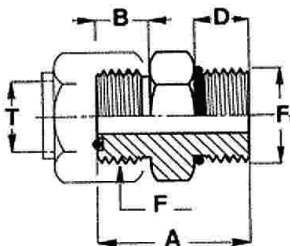
**502014
АДАПТЕР ORFS/ SAE
СТАЛЬ**

Артикул Сталь	Резьба		Размеры, мм		
	F (UNF)	F1 (UNF-UN)	A	B	D
A502014-0611	9/16-18	7/16-18	29	10	10
A502014-0614	9/16-18	9/16-18	30,5	10	10
A502014-1014	11/16-16	9/16-18	32	11	11
A502014-1019	11/16-16	3/4-16	35	11	11
A502014-1214	13/16-16	9/16-18	37,5	13	13
A502014-1219	13/16-16	3/4-16	37	13	13
A502014-1222	13/16-16	7/8-14	40,5	13	13
A502014-1619	1-14	3/4-16	45	15,5	15,5
A502014-1622	1-14	7/8-14	43	15,5	15,5
A502014-1627	1-14	1 1/16-12	47	15,5	15,5
A502014-2027	1 3/16-12	1 1/16-12	48,5	17	17
A502014-2033	1 3/16-12	1 5/16-12	50	17	17
A502014-2527	1 7/16-12	1 1/16-12	54	17,5	17,5
A502014-2533	1 7/16-12	1 5/16-12	50,5	17,5	17,5
A502014-2541	1 7/16-12	1 5/8-12	52	17,5	17,5
A502014-3241	1 11/16-12	1 5/8-12	52	17,5	17,5
A502014-3848	2-12	1 7/8-12	54	17,5	17,5

502025
Адаптер
ORFS /BSPP
СТАЛЬ

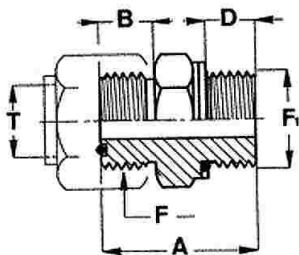

Артикул Сталь	Резьба		Размеры, мм		
	F (UNF/S-UN)	F1 (BSPP)	A	B	D
A502025-0610	9/16-18	1/8	25	10	8
A502025-0613	9/16-18	1/4	30	10	10
A502025-0617	9/16-18	3/8	31	10	10
A502025-1013	11/16-16	1/4	31,5	11	10
A502025-1017	11/16-16	3/8	32,5	11	10
A502025-1021	11/16-16	1/2	36	11	12
A502025-1213	13/16-16	1/4	38	13	10
A502025-1217	13/16-16	3/8	33,5	13	10
A502025-1221	13/16-16	1/2	37	13	12
A502025-1617	1-14	3/8	36,5	15,5	10
A502025-1621	1-14	1/2	39,5	15,5	12
A502025-1626	1-14	3/4	43,5	15,5	14
A502025-2021	1 3/16-12	1/2	43	17	12
A502025-2026	1 3/16-12	3/4	45	17	14
A502025-2033	1 3/16-12	1	47,5	17	15,5
A502025-2526	1 7/16-12	3/4	46	17,5	14
A502025-2533	1 7/16-12	1	48	17,5	15,5
A502025-2542	1 7/16-12	1 1/4	51,5	17,5	17,5
A502025-3233	1 11/16-12	1	49,5	17,5	15,5
A502025-3242	1 11/16-12	1 1/4	51,5	17,5	17,5
A502025-3248	1 11/16-12	1 1/2	55,5	17,5	19,5
A502025-3848	2-12	1 1/2	55,5	17,5	19,5

502036
Адаптер
ORFS/M
СТАЛЬ

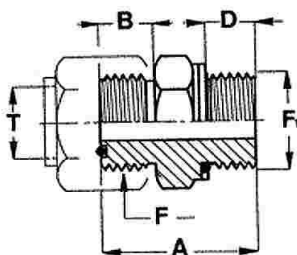

Артикул Сталь	Резьба		Размеры, мм		
	F (UNF)	F1 (метрическая резьба)	A	B	B1
A502036-0610	9/16-18	10x1	27	10	10
A502036-0612	9/16-18	12x1,5	28,5	10	10
A502036-1014	11/16-16	14x1,5	30,5	11	11
A502036-1016	11/16-16	16x1,5	32	11	11
A502036-1218	13/16-16	18x1,5	36	13	13
A502036-1222	13/16-16	22x1,5	39	13	13
A502036-1622	1-14	22x1,5	40,5	15,5	15,5
A502036-1627	1-14	27x2	46	15,5	15,5
A502036-2027	1 3/16-12	27x2	47	17	17
A502036-2033	1 3/16-12	33x2	48	17	17
A502036-2533	1 7/16-12	33x2	48,5	17,5	17,5
A502036-2542	1 7/16-12	42x2	51	17,5	17,5
A502036-3242	1 11/16-12	42x2	51	17,5	17,5
A502036-3248	1 11/16-12	48x2	55,5	17,5	17,5
A502036-3848	2-12	48x2	55,5	17,5	17,5

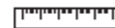
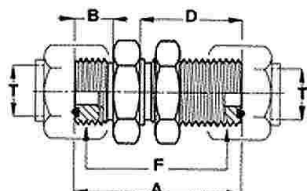
503000
АДАПТЕР ORFS /
ORFS
СТАЛЬ

Артикул Сталь	Резьба	Размеры, мм		
	F(UNF)	A	B	D
A503000-06	9/16-18	48	10	31,5
A503000-10	11/16-16	53	11	34
A503000-12	13/16-16	58	13	36,5
A503000-16	1-14	66,5	15,5	40,5
A503000-20	1 3/16-12	69	17	41,5
A503000-25	1 7/16-12	70	17,5	42
A503000-32	1 11/16-12	70	17,5	42
A503000-38	2-12	70	17,5	42

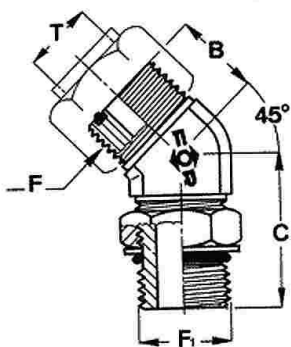
505007
45° АДАПТЕР ORFS /
SAE
СТАЛЬ

Артикул Сталь	Резьба		Размеры, мм	
	F (UNF)	F1 (UNF-UN)	B	C
A505007-0611	9/16-18	7/16-20	16	30
A505007-0614	9/16-18	9/16-18	17,5	33
A505007-1011	11/16-16	7/16-20	19	31
A505007-1014	11/16-16	9/16-18	19	33
A505007-1019	11/16-16	3/4-16	19	36,5
A505007-1214	13/16-16	9/16-18	20,5	32,5
A505007-1219	13/16-16	3/4-16	20,5	36,5
A505007-1222	13/16-16	7/8-14	21	45
A505007-1619	1-14	3/4-16	23,5	40,5
A505007-1622	1-14	7/8-14	23,5	45
A505007-1627	1-14	1 1/16-12	24,5	50
A505007-2022	1 3/16-12	7/8-20	26	46
A505007-2027	1 3/16-12	1 1/16-12	26	50
A505007-2033	1 3/16-12	1 5/16-12	29,5	52,5
A505007-2527	1 7/16-12	1 1/16-12	30	51,5
A505007-2533	1 7/16-12	1 5/16-12	30	52,5
A505007-2541	1 7/16-12	1 5/8-12	32	53,5
A505007-3241	1 11/16-12	1 5/8-12	32	53,5
A505007-3848	2-12	1 7/8-12	37	53,5

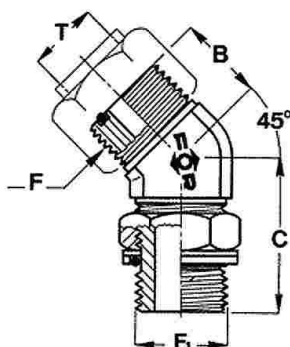
505018
45° АДАПТЕР ORFS /
BSPP
СТАЛЬ

Артикул Сталь	Резьба		Размеры, мм	
	F (UNF)	F1(BSPP)	B	C
A505018-0610	9/16-18	1/8	16	28
A505018-0613	9/16-18	1/4	17,5	31
A505018-1013	11/16-16	1/4	19	32
A505018-1017	11/16-16	3/8	19	33
A505018-1021	11/16-16	1/2	19,5	43
A505018-1217	13/16-16	3/8	20,5	33,5
A505018-1621	1-14	1/2	23,5	42
A505018-1626	1-14	3/4	24,5	46,5
A505018-2026	1 3/16-12	3/4	26	50
A505018-2033	1 3/16-12	1	29,5	52,5
A505018-2533	1 7/16-12	1	30	52,5
A505018-3242	1 11/16-12	1 1/4	32	53,5
A505018-3848	2-12	1 1/2	37	53,5

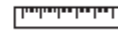
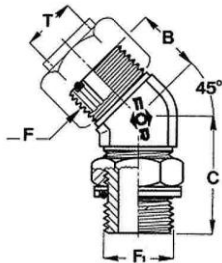
505029
**Адаптер 45°
ORFS / M
СТАЛЬ**

Артикул Сталь	Резьба		Размеры, мм		
	F (UNF)	F1 (метрическая резьба)	L1	L2	
A505029-0612	9/16-18	M12x1,5	16	30	
A505029-1016	11/16-16	M16x1,5	19	33	
A505029-1218	13/16-16	M18x1,5	20,5	36,5	
A505029-1622	1-14	M22x1,5	23,5	45	
A505029-2027	1 3/16-12	M27x2	26	50	
A505029-2533	1 7/16-12	M33x2	30	52,5	
A505029-3242	1 11/16-12	M42x2	32	53,5	
A505029-3848	2-12	M48x2	37	55,5	

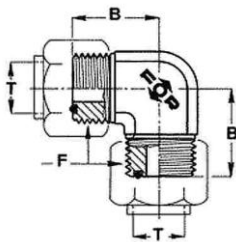
507009
**Адаптер 90°
ORFS / ORFS
СТАЛЬ**

Артикул Сталь	Резьба		Размеры, мм	
	F1 (UNF)		B	
A507009-06	9/16-18		21,5	
A507009-10	11/16-16		25	
A507009-12	13/16-16		28	
A507009-16	1-14		33,5	
A507009-20	1 3/16-12		37,5	
A507009-25	1 7/16-12		42	
A507009-32	1 11/16-12		45	
A507009-38	2-12		49	

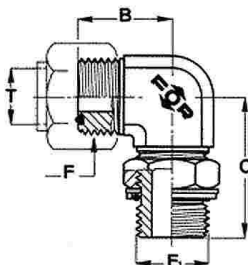
507032
**Адаптер 90°
ORFS/BSPP
СТАЛЬ**

Артикул Сталь	Резьба		Размеры, мм		
	F (UNF/S-UN)	F1 (BSPP)	B	C	
A507032-0610	9/16-18	1/8	21,5	30	
A507032-0613	9/16-18	1/4	23,5	35	
A507032-0617	9/16-18	3/8	25	38	
A507032-1013	11/16-16	1/4	25	36	
A507032-1017	11/16-16	3/8	26,5	38	
A507032-1021	11/16-16	1/2	29,5	48	
A507032-1213	13/16-16	1/4	28	35	
A507032-1217	13/16-16	3/8	28	38	
A507032-1221	13/16-16	1/2	31	48	
A507032-1617	1-14	3/8	33,5	43	
A507032-1621	1-14	1/2	33,5	48	
A507032-1626	1-14	3/4	36	51,5	
A507032-2021	1 3/16-12	1/2	37,5	49	
A507032-2026	1 3/16-12	3/4	37,5	51,5	
A507032-2033	1 3/16-12	1	41,5	58	
A507032-2526	1 7/16-12	3/4	42	56	
A507032-2533	1 7/16-12	1	42	58	
A507032-2542	1 7/16-12	1 1/4	45	60,5	
A507032-3233	1 11/16-12	1	45	60	
A507032-3242	1 11/16-12	1 1/4	45	60,5	
A507032-3248	1 11/16-12	1 1/2	49	64,5	
A507032-3848	2-12	1 1/2	49	64,5	



507021
90° АДАПТЕР ORFS/
SAE
СТАЛЬ

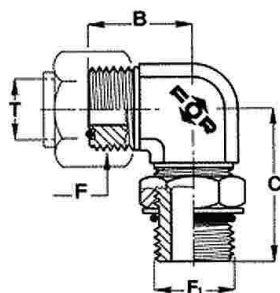

Артикул Сталь	Резьба		Размеры, мм		
	F (UNF)	F1 (UNF-UN)	B	C	
A507021-0611	9/16-18	7/16-20	21,5	32,5	
A507021-0614	9/16-18	9/16-18	23,5	37	
A507021-1011	11/16-16	7/16-20	25	35	
A507021-1014	11/16-16	9/16-18	25	37	
A507021-1019	11/16-16	3/4-16	26,5	40,5	
A507021-1214	13/16-16	9/16-18	28	36,5	
A507021-1219	13/16-16	3/4-16	28	40,5	
A507021-1222	13/16-16	7/8-14	31	50	
A507021-1619	1-14	3/4-16	33,5	46	
A507021-1622	1-14	7/8-14	33,5	50	
A507021-1627	1-14	1 1/16-12	36	55	
A507021-2022	1 3/16-12	7/8-20	37,5	51	
A507021-2027	1 3/16-12	1 1/16-12	37,5	55	
A507021-2033	1 3/16-12	1 5/16-12	41,5	60	
A507021-2527	1 7/16-12	1 1/16-12	42	59	
A507021-2533	1 7/16-12	1 5/16-12	42	60	
A507021-2541	1 7/16-12	1 5/8-12	45	62	
A507021-3233	1 11/16-12	1 5/16-12	45	62	
A507021-3241	1 11/16-12	1 5/8-12	45	62	
A507021-3248	1 11/16-12	1 7/8-12	49	66	
A507021-3848	2-12	1 7/8-12	49	66	

507043
90° АДАПТЕР ORFS/
M
СТАЛЬ

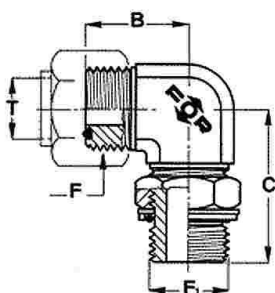

Артикул Сталь	Резьба		Размеры, мм		
	F (UNF)	F1 (метрическая резьба)	B	C	
A507043-0610	9/16-18	10x1	21,5	32,5	
A507043-0612	9/16-18	12x1,5	21,5	32,5	
A507043-1014	11/16-16	14x1,5	25	37	
A507043-1016	11/16-16	16x1,5	25	37	
A507043-1218	13/16-16	18x1,5	28	40,5	
A507043-1222	13/16-16	22x1,5	31	50	
A507043-1622	1-14	22x1,5	33,5	50	
A507043-1627	1-14	27x2	36	51,5	
A507043-2027	1 3/16-12	27x2	37,5	55	
A507043-2033	1 3/16-12	33x2	41,5	60	
A507043-2533	1 7/16-12	33x2	42	60	
A507043-2542	1 7/16-12	42x2	45	60	
A507043-3242	1 11/16-12	42x2	45	62	
A507043-3248	1 11/16-12	48x2	49	66	
A507043-3848	2-12	48x2	49	66	

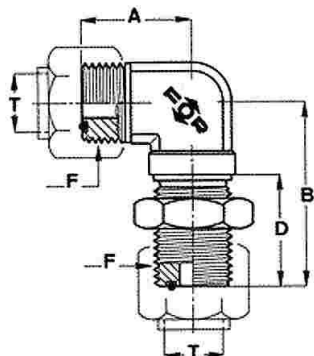
508004
**Адаптер 90°
ORFS / ORFS**
СТАЛЬ

Артикул Сталь	Резьба	Размеры, мм		
	F (UNF)	A	B	C
A508004-06	9/16-18	22,5	47	31,5
A508004-10	11/16-16	26	52	34
A508004-12	13/16-16	29	55,5	36,5
A508004-16	1-14	34,5	63	40,5
A508004-20	1 3/16-12	38,5	67	41,5
A508004-25	1 7/16-12	42,5	71	42
A508004-32	1 11/16-12	45,5	75,5	42
A508004-38	2-12	49,5	79,5	42

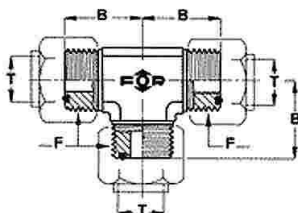
511004
**Адаптер
ORFS / UNF**
СТАЛЬ

Артикул Сталь	Резьба	Размеры, мм	
	F (UNF)	B	C
A511004-06	9/16-18	21,5	
A511004-10	11/16-16	25	
A511004-12	13/16-16	28	
A511004-16	1-14	33,5	
A511004-20	1 3/16-12	37,5	
A511004-25	1 7/16-12	42	
A511004-32	1 11/16-12	45	
A511004-38	2-12	49	

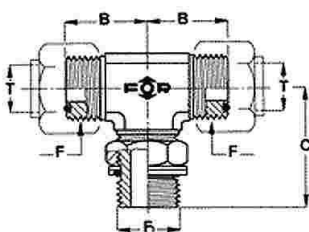
511037
**Адаптер
ORFS/BSPP**
СТАЛЬ

Артикул Сталь	Резьба		Размеры, мм		
	F (UNF/S-UN)	F1 (BSPP)	B	C	D
A511037-0610	9/16-18	1/8	21,5	30	
A511037-0613	9/16-18	1/4	23,5	35	
A511037-1013	11/16-16	1/4	25	36	
A511037-1017	11/16-16	3/8	26,5	38	
A511037-1217	13/16-16	3/8	28	38	
A511037-1221	13/16-16	1/2	31	48	
A511037-1621	1-14	1/2	33,5	48	
A511037-1626	1-14	3/4	36	51,5	
A511037-2026	1 3/16-12	3/4	37,5	51,5	
A511037-2533	1 7/16-12	1	42	58	
A511037-3242	1 11/16-12	1 1/4	45	60,5	
A511037-3848	2-12	1 1/2	49	64,5	

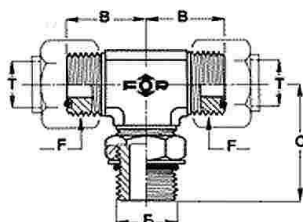
511026
АДАПТЕР ORFS/ SAE
СТАЛЬ

Артикул Сталь	Резьба		Размеры, мм	
	F (UNF/S-UN)	F1 (UNF-UN)	B	C
A511026-0611	9/16-18	7/16-20	21,5	32,5
A511026-1014	11/16-16	9/16-18	25	37
A511026-1219	13/16-16	3/4-16	28	40,5
A511026-1622	1-14	7/8-14	33,5	50
A511026-2027	1 3/16-12	1 1/16-12	37,5	55
A511026-2533	1 7/16-12	1 5/16-12	42	60
A511026-3241	1 11/16-12	1 5/8-12	45	62
A511026-3848	2-12	1 7/8-12	49	66

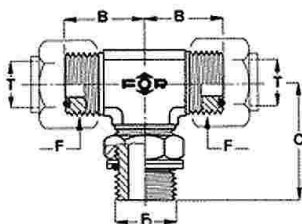
511048
T - АДАПТЕР ORFS/ M
СТАЛЬ

Артикул Сталь	Резьба		Размеры, мм	
	F (UNF)	F1 (метрическая резьба)	B	C
A511048-0612	9/16-18	12x1,5	21,5	32,5
A511048-1016	11/16-16	16x1,5	25	37
A511048-1218	13/16-16	18x1,5	28	40,5
A511048-1622	1-14	22x1,5	33,5	50
A511048-2027	1 3/16-12	27x2	37,5	55
A511048-2533	1 7/16-12	33x2	42	60
A511048-3242	1 11/16-12	42x2	45	62
A511048-3848	2-12	48x2	49	66

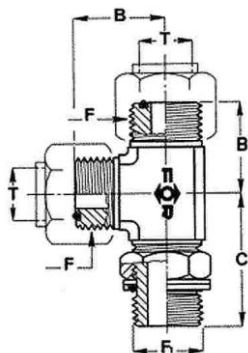
513023
Адаптер
ORFS/BSPP
СТАЛЬ

Артикул Сталь	Резьба		Размеры, мм	
	F (UNF/S-UN)	F1 (BSPP)	B	C
A513023-0610	9/16-18	1/8	21,5	30
A513023-0613	9/16-18	1/4	23,5	35
A513023-1013	11/16-16	1/4	25	36
A513023-1017	11/16-16	3/8	26,5	38
A513023-1217	13/16-16	3/8	28	38
A513023-1221	13/16-16	1/2	31	48
A513023-1621	1-14	1/2	33,5	48
A513023-1626	1-14	3/4	36	51,5
A513023-2026	1 3/16-12	3/4	37,5	51,5
A513023-2033	1 3/16-12	1	41,5	58
A513023-2533	1 7/16-12	1	42	58
A513023-3242	1 11/16-12	1 1/4	45	60,5
A513023-3848	2-12	1 1/2	49	64,5

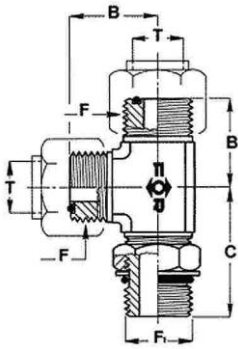
513012
**Адаптер
ORFS /SAE
СТАЛЬ**

Артикул Сталь	Резьба		Размеры, мм		
	F (UNF/S-UN)	F1 (UNF-UN)	B	C	
A513012-0611	9/16-18	7/16-20	21,5	32,5	
A513012-1014	11/16-16	9/16-18	25	37	
A513012-1219	13/16-16	¾-16	28	40,5	
A513012-1622	1-14	7/8-14	33,5	50	
A513012-2027	1 3/16-12	1 1/16-12	37,5	55	
A513012-2533	1 7/16-12	1 5/16-12	42	60	
A513012-3241	1 11/16-12	1 5/8-12	45	62	
A513012-3848	2-12	1 7/8-12	49	66	

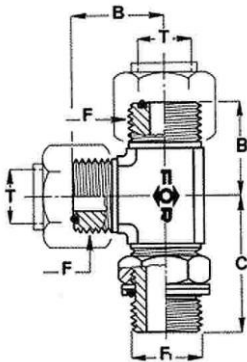
513034
**Адаптер
ORFS/M
СТАЛЬ**

Артикул Сталь	Резьба		Размеры, мм		
	F (UNF)	F1 (метрическая резьба)	B	C	
A513034-0612	9/16-18	M12x1,5	21,5	32,5	
A513034-1016	11/16-16	M16x1,5	25	37	
A513034-1218	13/16-16	M18x1,5	28	40,5	
A513034-1622	1-14	M22x1,5	33,5	50	
A513034-2027	1 3/16-12	M27x2	37,5	55	
A513034-2533	1 7/16-12	M33x2	42	60	
A513034-3242	1 11/16-12	M42x2	45	62	
A513034-3848	2-12	M48x2	49	66	